



# ROAD RESCUE EMERGENCY VEHICLES E-450 ULTRAMEDIC // WALK-THROUGH



DO NOT CUT HOLES FOR COMPARTMENT LIGHTING

**FL** - INDICATES A FULL HEIGHT FLEXIBLE LIGHTING STRIP

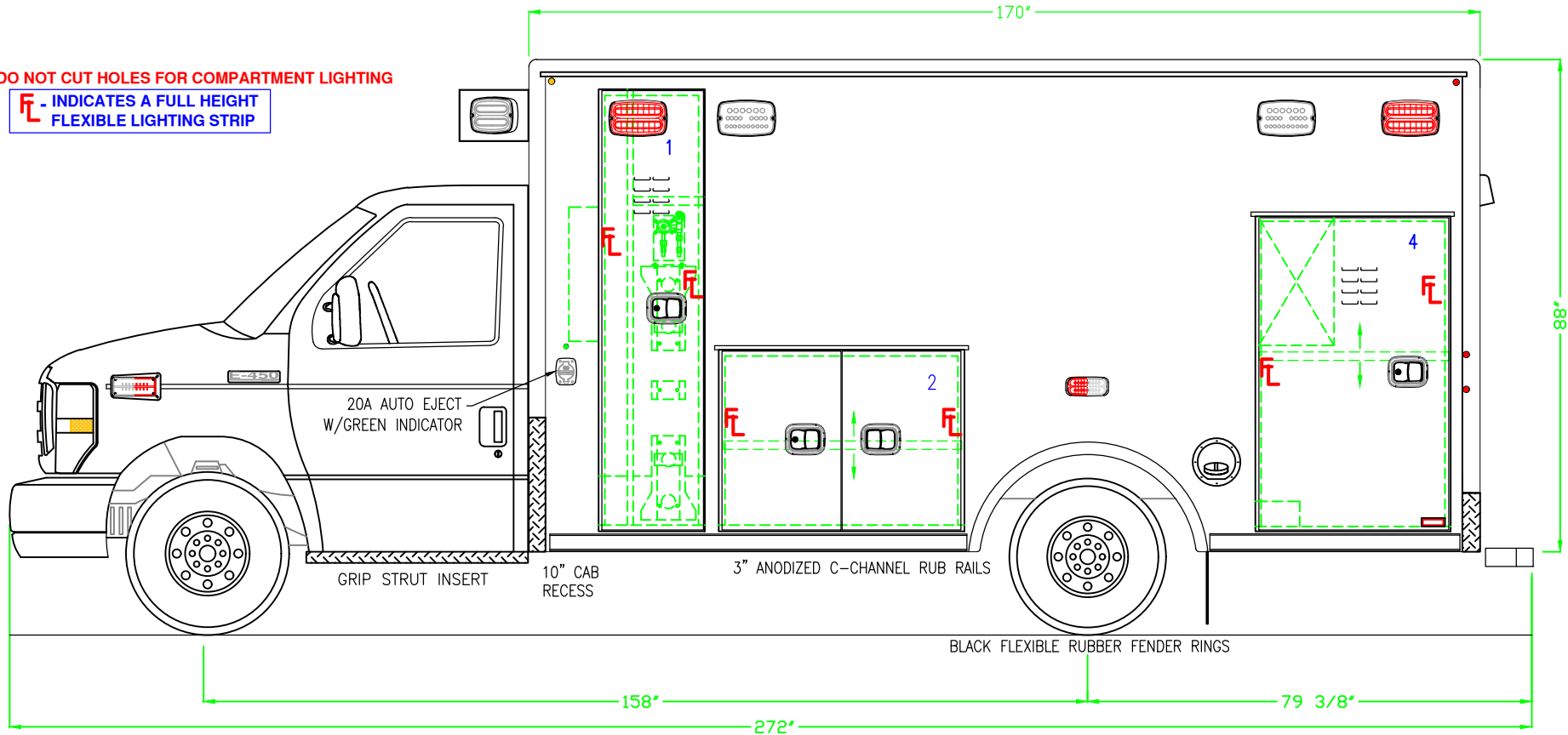

| DOOR NO. | INTERIOR DIMENSIONS |        |                           | NOTES                             | NOTES:  | PROPRIETARY AND CONFIDENTIAL<br>THIS INFORMATION CONTAINED IN THIS DRAWING IS THE SOLE PROPERTY OF ROAD RESCUE ANY REPRODUCTION IN PART OR AS A WHOLE WITHOUT THE WRITTEN PERMISSION OF ROAD RESCUE IS PROHIBITED. |
|----------|---------------------|--------|---------------------------|-----------------------------------|---|--|
|          | HEIGHT              | WIDTH  | DEPTH                     |                                   |   |  |
| 1        | 78.00"              | 19.37" | 22.12" TOP, 21.31" BOTTOM | FIXED DIVIDER & SHELF, O2 STORAGE | DETAILS ARE CONCEPTUAL ONLY. LAYOUT AND ALL DIMENSIONS ARE APPROXIMATE AND SUBJECT TO MODIFICATION BY DESIGN ENGINEERING. |  |
| 2        | 31.37"              | 43.87" | 19.25"                    | (1) ADJ. SHELF                    |   |  |
| 4        | 55.50"              | 35.00" | 19.25"                    | (1) ADJ. SHELF                    |   |  |

|  |                    |  |            |                                   |       |               |            |  |
|--|--------------------|--|------------|-----------------------------------|-------|---------------|------------|--|
| <b>Road Rescue</b>                                     |                    | 2737 N. Forsyth Rd.<br>Winter Park, FL 32792 |            | <b>STREETSIDE EXTERIOR DETAIL</b> |       |               | BID NUMBER |  |
| www.roadrescue.com PHONE 800-932-7077 FAX 800-513-2688 |                    |  |            |                                   |       |               | 633973     |  |
| DRAWN BY<br>GDG  | DATE<br>12/06/2022 | REVISION 1                                   | REVISION 2 | REVISION 3                        | SCALE | SHEET 1 OF 10 |            |  |

NOTE: THIS DRAWING IS SUBJECT TO CHANGE PENDING ROAD RESCUE PRODUCTION ENGINEERING APPROVAL. ©ROAD RESCUE ALL RIGHTS RESERVED.



# ROAD RESCUE EMERGENCY VEHICLES E-450 ULTRAMEDIC // WALK-THROUGH

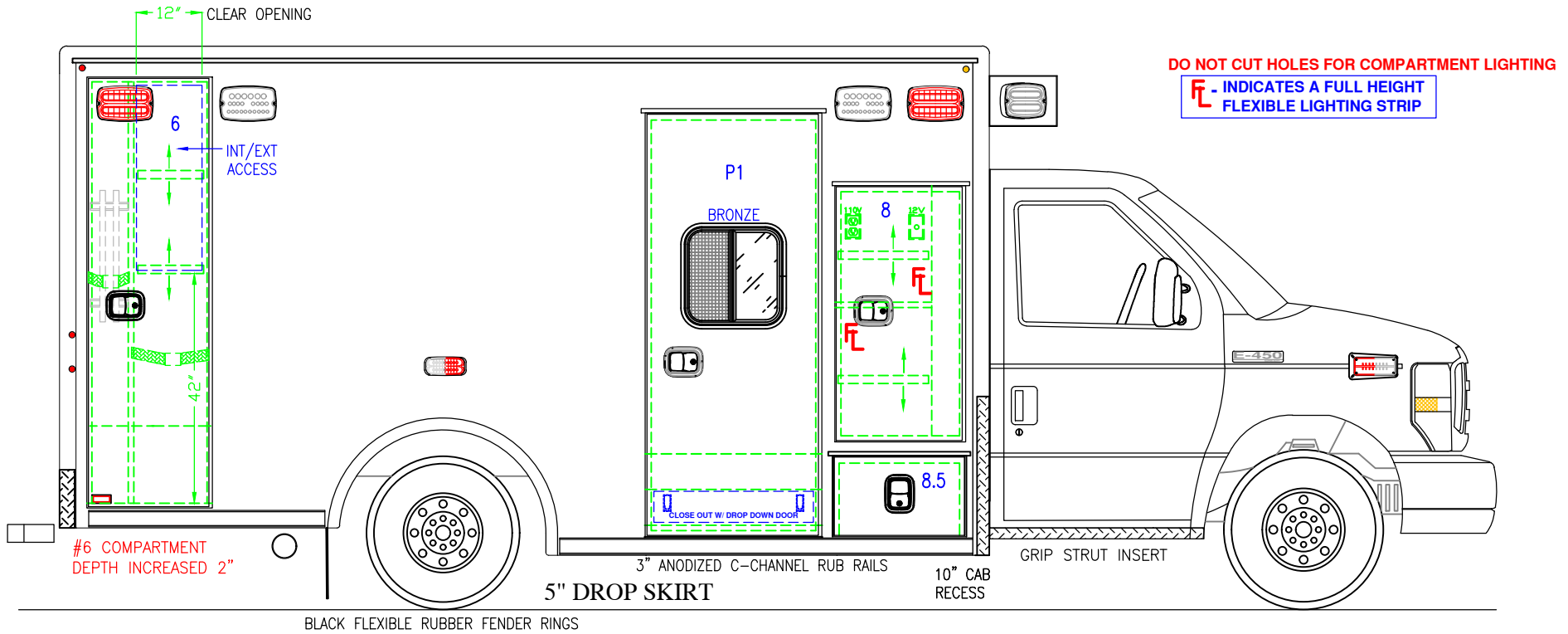

| DOOR NO.  | INTERIOR DIMENSIONS |        |                           | NOTES                            | DOOR NO. | DOOR DIMENSIONS |        | MISC. NOTES                   |
|---|---------------------|--------|---------------------------|----------------------------------|----------|-----------------|--------|-------------------------------|
|   | HEIGHT              | WIDTH  | DEPTH                     |                                  |          | HEIGHT          | WIDTH  |                               |
| 6   | 78.00"              | 22.75" | 21.87" TOP, 21.18" BOTTOM | (1) FIXED DIV., (2) ADJ. SHELVES | 8        | 46.31"          | 23.50" | RIGHT STACK/ALS ACCESS        |
| 8.5   | 13.50"              | 24.37" | 20.87"                    | BATTERY DRAWER FOR (3) BATTERIES | P1       | 77.00"          | 30.06" | 18"x18" SLIDING BRONZE WINDOW |
| DETAILS ARE CONCEPTUAL ONLY. LAYOUT AND ALL DIMENSIONS ARE APPROXIMATE AND SUBJECT TO MODIFICATION BY DESIGN ENGINEERING. |                     |        |                           |                                  |          |                 |        |                               |

PROPRIETARY AND CONFIDENTIAL  
THIS INFORMATION CONTAINED IN THIS DRAWING IS THE SOLE PROPERTY OF ROAD RESCUE ANY REPRODUCTION IN PART OR AS A WHOLE WITHOUT THE WRITTEN PERMISSION OF ROAD RESCUE IS PROHIBITED.

|  |                    |  |            |                                   |       |               |            |  |
|--|--------------------|--|------------|-----------------------------------|-------|---------------|------------|--|
| <b>Road Rescue</b>                                     |                    | 2737 N. Forsyth Rd.<br>Winter Park, FL 32792 |            | <h2>CURBSIDE EXTERIOR DETAIL</h2> |       |               | BID NUMBER |  |
| www.roadrescue.com PHONE 800-932-7077 FAX 800-513-2688 |                    |  |            |                                   |       |               | 633973     |  |
| DRAWN BY<br>GDG  | DATE<br>12/06/2022 | REVISION 1<br>12/22/2022                     | REVISION 2 | REVISION 3                        | SCALE | SHEET 2 OF 10 |            |  |

NOTE: THIS DRAWING IS SUBJECT TO CHANGE PENDING ROAD RESCUE PRODUCTION ENGINEERING APPROVAL. ©ROAD RESCUE ALL RIGHTS RESERVED.



# ROAD RESCUE EMERGENCY VEHICLES E-450 ULTRAMEDIC // WALK-THROUGH

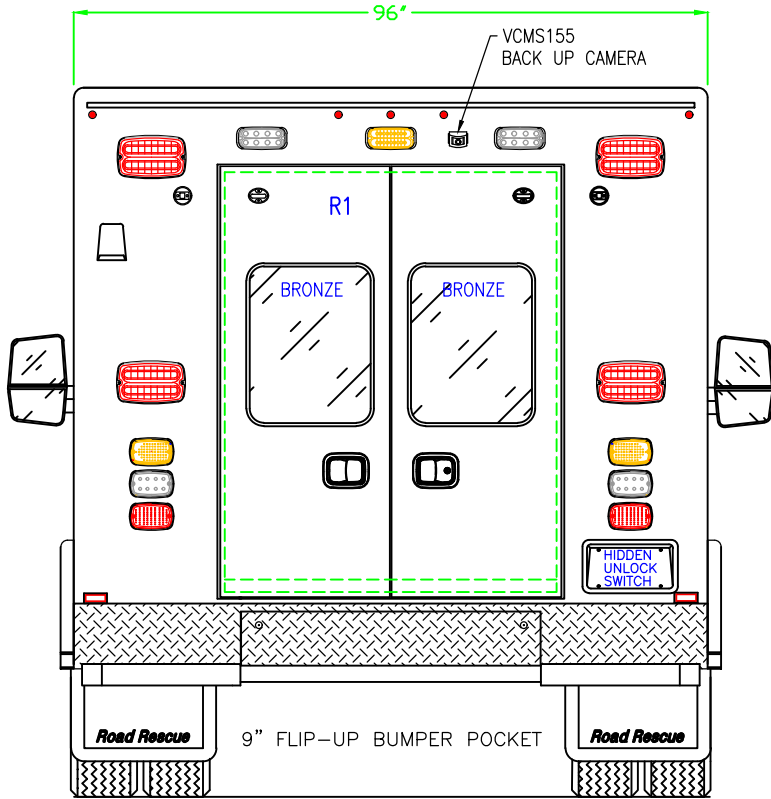

VELVAC  
2020XG  
MIRRORS

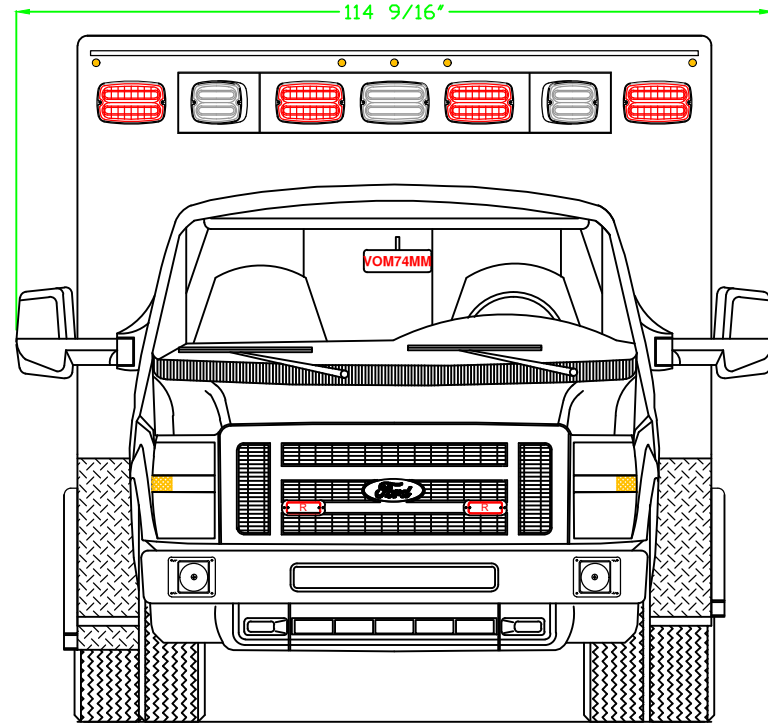

| DOOR NO. | DOOR JAM OPENING |        | NOTES                          |
|----------|------------------|--------|--------------------------------|
|          | HEIGHT           | WIDTH  |                                |
| R1       | 61.44"           | 50.25" | FIXED BRONZE WINDOWS 18" X 24" |

NOTES:

PROPRIETARY AND CONFIDENTIAL  
THIS INFORMATION CONTAINED IN THIS DRAWING IS THE SOLE PROPERTY OF ROAD RESCUE ANY REPRODUCTION IN PART OR AS A WHOLE WITHOUT THE WRITTEN PERMISSION OF ROAD RESCUE IS PROHIBITED.

DETAILS ARE CONCEPTUAL ONLY.  
LAYOUT AND ALL DIMENSIONS ARE APPROXIMATE AND SUBJECT TO MODIFICATION BY DESIGN ENGINEERING.

**Road Rescue**  
2737 N. Forsyth Rd.  
Winter Park, FL 32792  
www.roadrescue.com PHONE 800-932-7077 FAX 800-513-2688

## FRONT & REAR EXTERIOR DETAIL

BID NUMBER  
**633973**

|                 |                    |                          |                          |            |       |               |
|-----------------|--------------------|--------------------------|--------------------------|------------|-------|---------------|
| DRAWN BY<br>GDG | DATE<br>12/06/2022 | REVISION 1<br>12/22/2022 | REVISION 2<br>04/24/2023 | REVISION 3 | SCALE | SHEET 3 OF 10 |
|-----------------|--------------------|--------------------------|--------------------------|------------|-------|---------------|



# ROAD RESCUE EMERGENCY VEHICLES E-450 ULTRAMEDIC // WALK-THROUGH

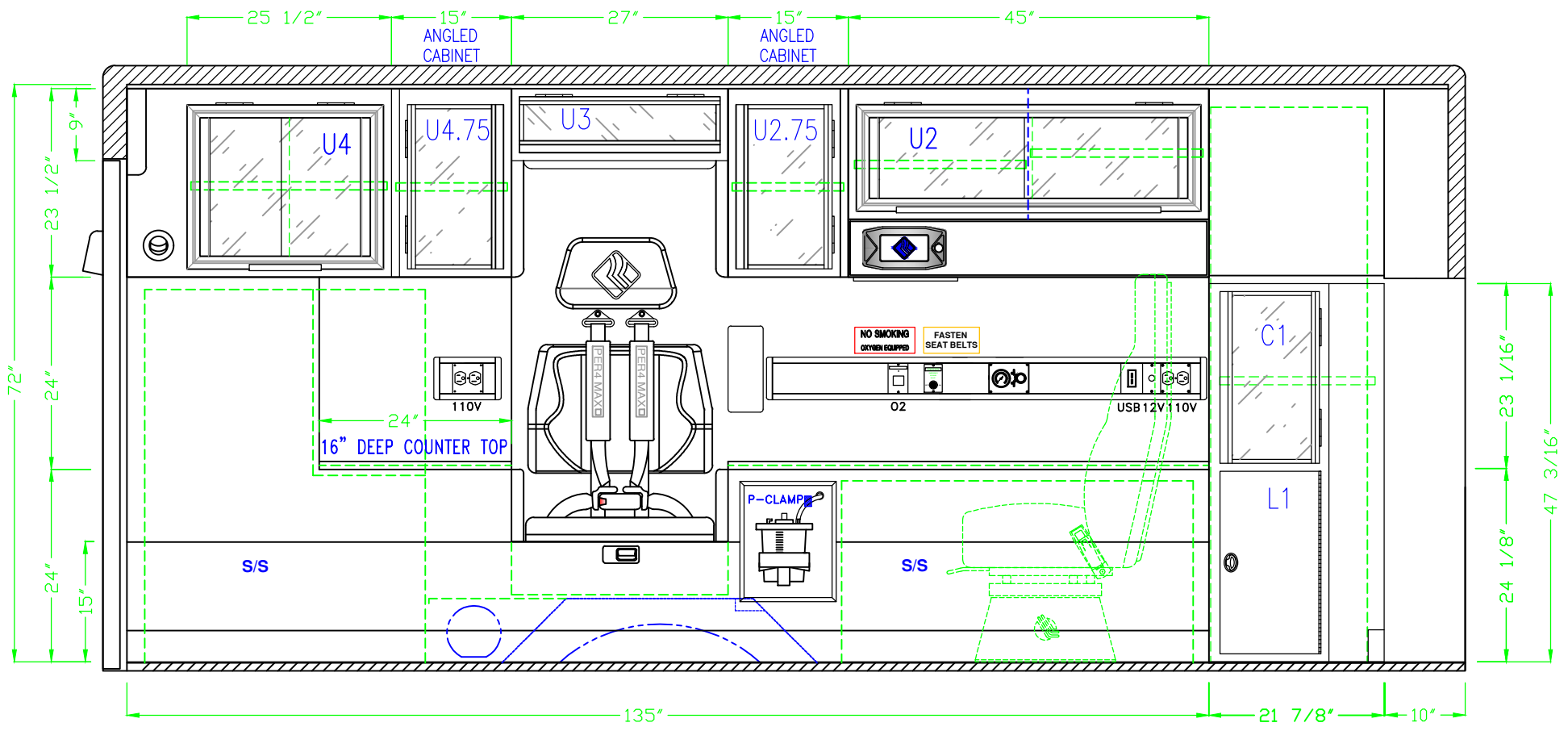

| DOOR NO. | INTERIOR DIMENSIONS |        |        | NOTES   |
|----------|---------------------|--------|--------|---|
|          | HEIGHT              | WIDTH  | DEPTH  |   |
| C1       | 23.00"              | 21.49" | 16.50" | OHO DOOR, (1) ADJ. SHELF                                    |
| L1       | 24.00"              | 21.49" | 16.50" | SINGLE ALUM. DOOR, LOCKING                                  |
| U2       | 16.00"              | 44.75" | 15.00" | SLIDING POLY DOORS, FIXED DIV. (2) ADJ. SHELVES, RESTOCKING |
| U3       | 8.75"               | 26.75" | 10.75" | OHO DOOR, RESTOCKING  |

| DOOR NO. | EXTERIOR DIMENSIONS |        |        | NOTES  |
|----------|---------------------|--------|--------|--|
|          | HEIGHT              | WIDTH  | DEPTH  |  |
| U4       | 23.25"              | 25.25" | 15.00" | SLIDING POLY DOORS, (1) ADJ. SHELF, RESTOCKING |

DETAILS ARE CONCEPTUAL ONLY. LAYOUT AND DIMENSIONS ARE APPROXIMATE AND SUBJECT TO MODIFICATION BY DESIGN ENGINEERING

PROPRIETARY AND CONFIDENTIAL  
THIS INFORMATION CONTAINED IN THIS DRAWING IS THE SOLE PROPERTY OF ROAD RESCUE ANY REPRODUCTION IN PART OR AS A WHOLE WITHOUT THE WRITTEN PERMISSION OF ROAD RESCUE IS PROHIBITED.

**Road Rescue**

2737 N. Forsyth Rd.  
Winter Park, FL 32792

## STREETSIDE INTERIOR DETAIL

BID NUMBER

www.roadrescue.com PHONE 800-932-7077 FAX 800-513-2688

DRAWN BY  
GDG

DATE  
12/06/2022

REVISION 1  
12/22/2022

REVISION 2

REVISION 3

SCALE

SHEET 4 OF 10

**633973**

NOTE: THIS DRAWING IS SUBJECT TO CHANGE PENDING ROAD RESCUE PRODUCTION ENGINEERING APPROVAL. ©ROAD RESCUE ALL RIGHTS RESERVED.

# ROAD RESCUE EMERGENCY VEHICLES E-450 ULTRAMEDIC // WALK-THROUGH

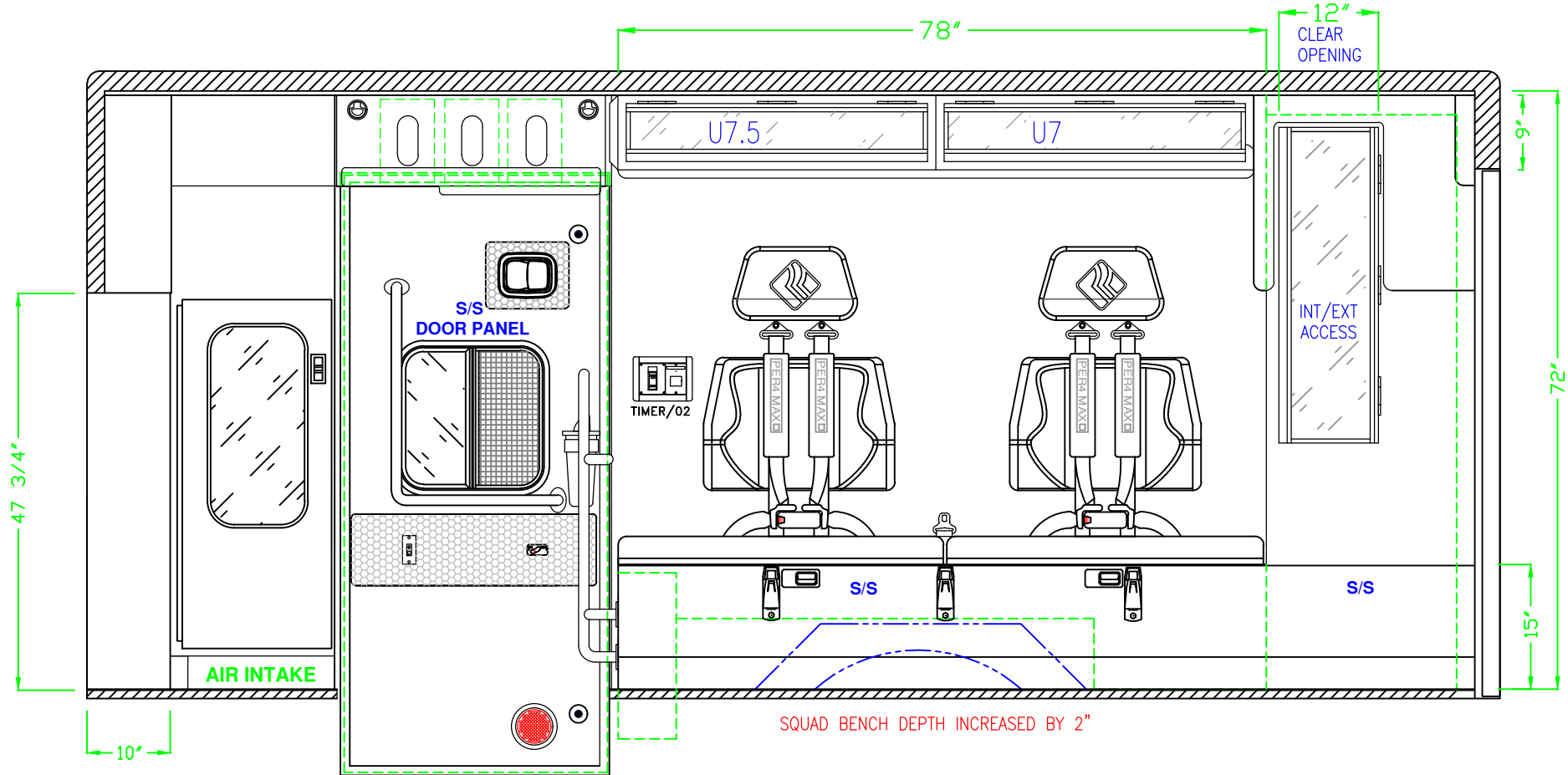

| DOOR NO. | INTERIOR DIMENSIONS |        |       | NOTES                        |
|----------|---------------------|--------|-------|------------------------------|
|          | HEIGHT              | WIDTH  | DEPTH |                              |
| U7       | 9.00"               | 40.00" | 8.50" | FLIP UP OHO DOOR, RESTOCKING |
| U7.5     | 9.00"               | 38.00" | 8.50" | FLIP UP OHO DOOR, RESTOCKING |



PROPRIETARY AND CONFIDENTIAL  
THIS INFORMATION CONTAINED IN THIS DRAWING IS THE SOLE PROPERTY OF ROAD RESCUE ANY REPRODUCTION IN PART OR AS A WHOLE WITHOUT THE WRITTEN PERMISSION OF ROAD RESCUE IS PROHIBITED.

DETAILS ARE CONCEPTUAL ONLY. LAYOUT AND DIMENSIONS ARE APPROXIMATE AND SUBJECT TO MODIFICATION BY DESIGN ENGINEERING

**Road Rescue** 2737 N. Forsyth Rd.  
Winter Park, FL 32792  
www.roadrescue.com PHONE 800-932-7077 FAX 800-513-2688

DRAWN BY GDC DATE 12/06/2022 REVISION 1 REVISION 2 REVISION 3 SCALE

## CURBSIDE INTERIOR DETAIL

BID NUMBER  **633973** 

# ROAD RESCUE EMERGENCY VEHICLES E-450 ULTRAMEDIC // WALK-THROUGH

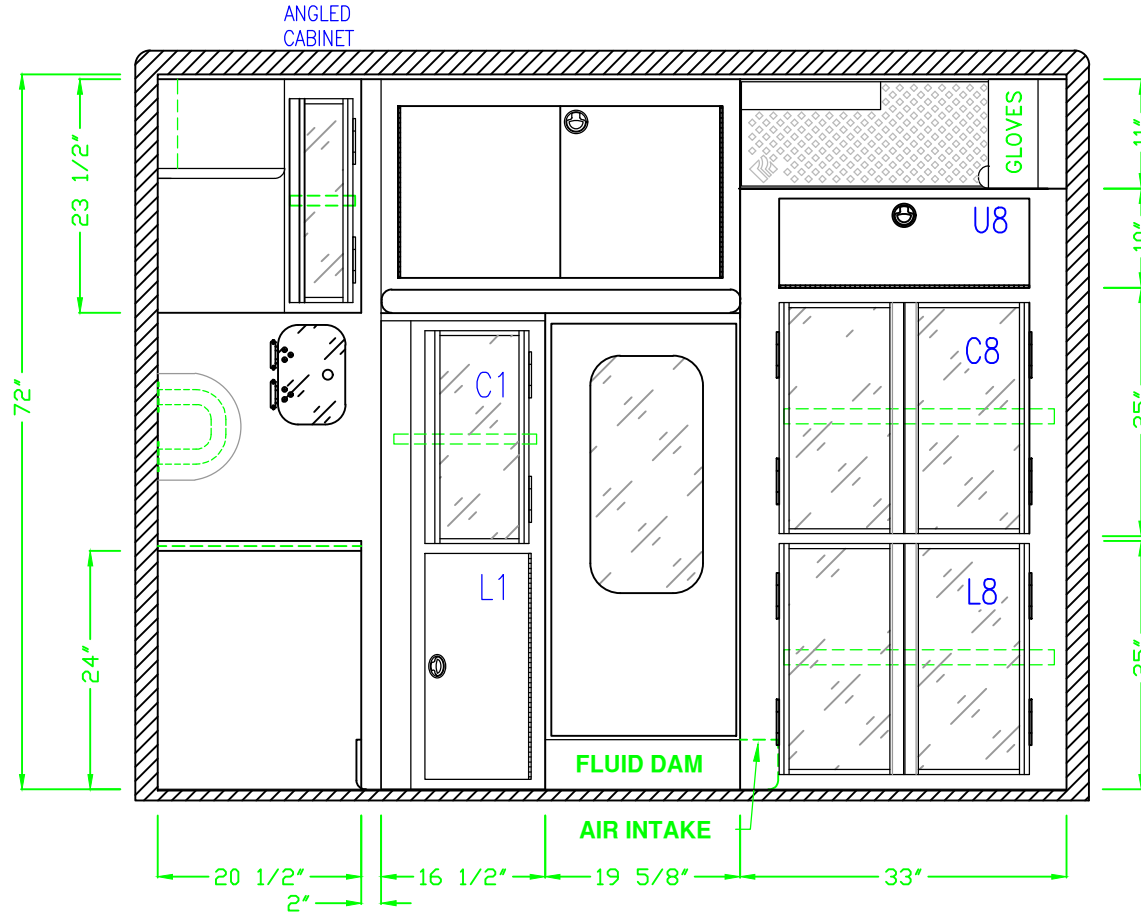

| DOOR NO. | CABINET DIMENSIONS |        |        | MISC. NOTES                      |
|----------|--------------------|--------|--------|----------------------------------|
|          | HEIGHT             | WIDTH  | DEPTH  |                                  |
| U8       | 10.00"             | 25.00" | 20.00" | SINGLE SOLID ALUM, LOCKING LATCH |
| C8       | 25.00"             | 28.00" | 20.00" | OHO DOORS, (1) ADJ. SHELF        |
| L8       | 25.00"             | 28.00" | 20.00" | OHO DOORS, (1) ADJ. SHELF        |

**NOTES:**

DETAILS ARE CONCEPTUAL ONLY. LAYOUT AND DIMENSIONS ARE APPROXIMATE AND SUBJECT TO MODIFICATION BY DESIGN ENGINEERING

PROPRIETARY AND CONFIDENTIAL  
THIS INFORMATION CONTAINED IN THIS DRAWING IS THE SOLE PROPERTY OF ROAD RESCUE ANY REPRODUCTION IN PART OR AS A WHOLE WITHOUT THE WRITTEN PERMISSION OF ROAD RESCUE IS PROHIBITED.

|  |                    |  |            |                              |       |               |  |  |
|--|--------------------|--|------------|------------------------------|-------|---------------|--|--|
| <b>Road Rescue</b>                                     |                    | 2737 N. Forsyth Rd.<br>Winter Park, FL 32792 |            | <b>FRONT INTERIOR DETAIL</b> |       |               | BID NUMBER   |  |
| www.roadrescue.com PHONE 800-932-7077 FAX 800-513-2688 |                    |  |            |                              |       |               |  <span style="font-size: 2em; font-weight: bold;">633973</span>  |  |
| DRAWN BY<br>GDG  | DATE<br>12/06/2022 | REVISION 1                                   | REVISION 2 | REVISION 3                   | SCALE | SHEET 6 OF 10 |  |  |

# ROAD RESCUE EMERGENCY VEHICLES E-450 ULTRAMEDIC // WALK-THROUGH

DEALER SIGNATURE 

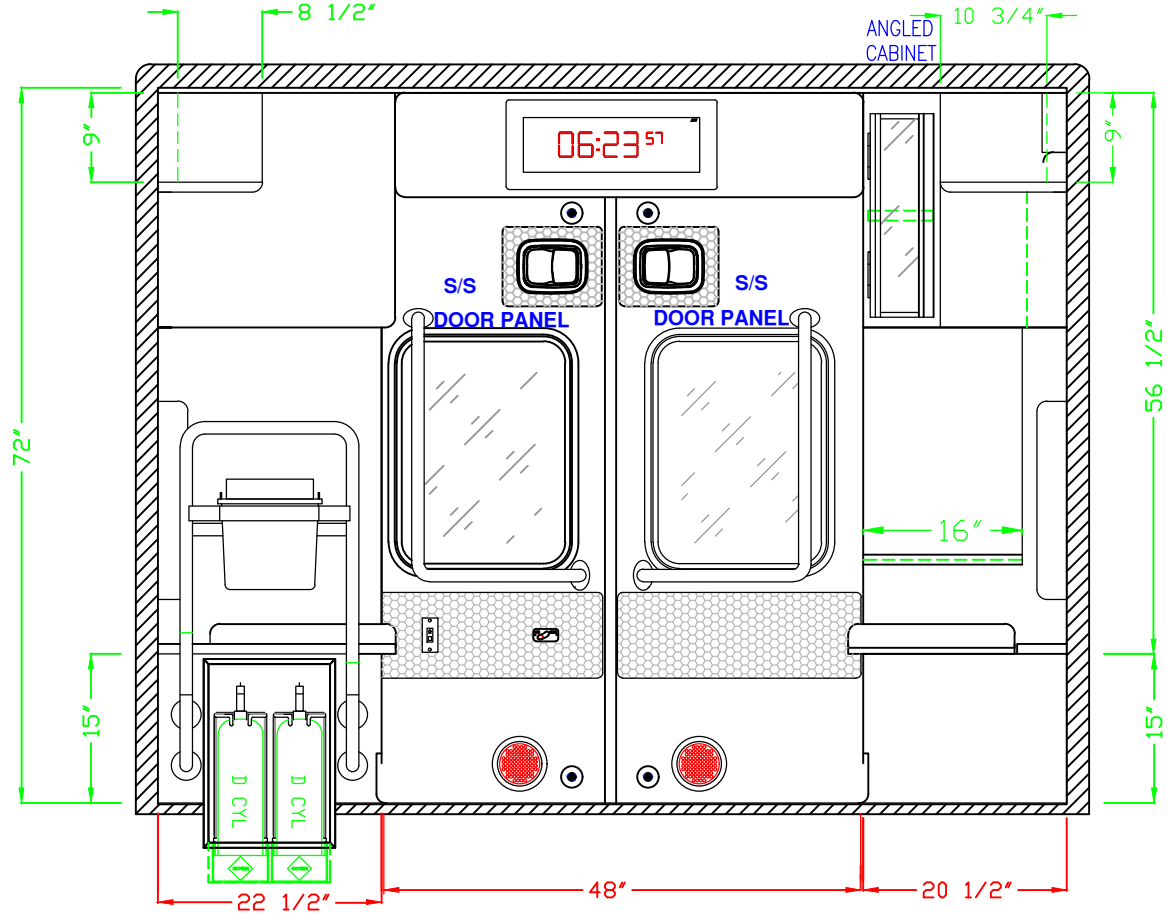



PROPRIETARY AND CONFIDENTIAL  
THIS INFORMATION CONTAINED IN THIS DRAWING IS THE SOLE PROPERTY OF ROAD RESCUE ANY REPRODUCTION IN PART OR AS A WHOLE WITHOUT THE WRITTEN PERMISSION OF ROAD RESCUE IS PROHIBITED.

DETAILS ARE CONCEPTUAL ONLY. LAYOUT AND DIMENSIONS ARE APPROXIMATE AND SUBJECT TO MODIFICATION BY DESIGN ENGINEERING

**Road Rescue**  
2737 N. Forsyth Rd.  
Winter Park, FL 32792  
www.roadrescue.com PHONE 800-932-7077 FAX 800-513-2688

DRAWN BY: GDG  
DATE: 12/06/2022  
REVISION 1: 12/22/2022

## REAR INTERIOR DETAIL

BID NUMBER  
 **633973** 



# ROAD RESCUE EMERGENCY VEHICLES E-450 ULTRAMEDIC // WALK-THROUGH

DEALER SIGNATURE

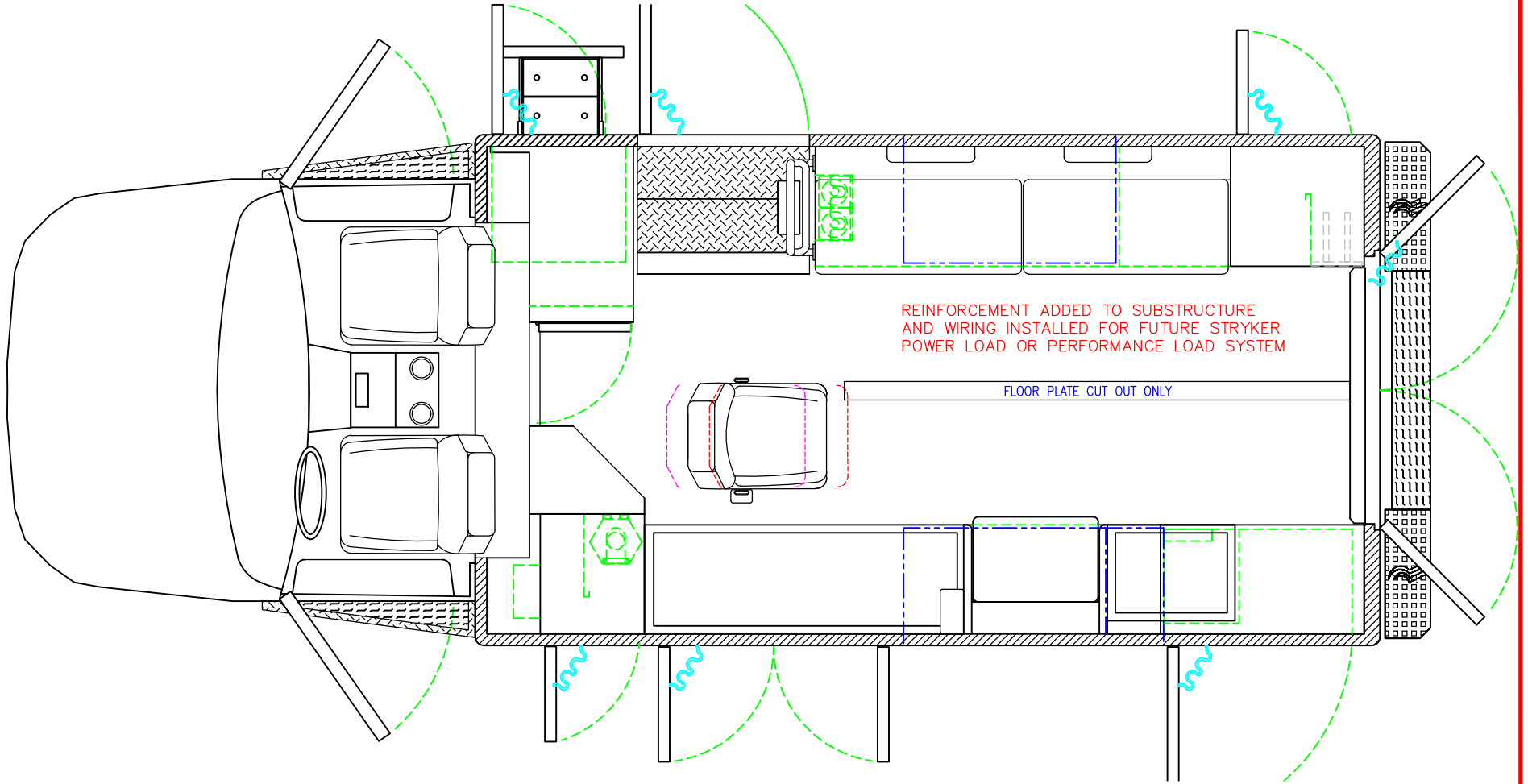

DETAILS ARE CONCEPTUAL ONLY LAYOUT AND ALL DIMENSIONS ARE APPROXIMATE AND SUBJECT TO MODIFICATION BY DESIGN ENGINEERING.

PROPRIETARY AND CONFIDENTIAL  
THIS INFORMATION CONTAINED IN THIS DRAWING IS THE SOLE PROPERTY OF ROAD RESCUE ANY REPRODUCTION IN PART OR AS A WHOLE WITHOUT THE WRITTEN PERMISSION OF ROAD RESCUE IS PROHIBITED.

**Road Rescue** 2737 N. Forsyth Rd.  
Winter Park, FL 32792  
www.roadrescue.com PHONE 800-932-7077 FAX 800-513-2688  
DRAWN BY DATE REVISION 1 REVISION 2 REVISION 3 SCALE  
GDG 12/06/2022

## OVERHEAD FLOOR DETAIL

BID NUMBER  
 633973





# ROAD RESCUE EMERGENCY VEHICLES E-450 ULTRAMEDIC // WALK-THROUGH

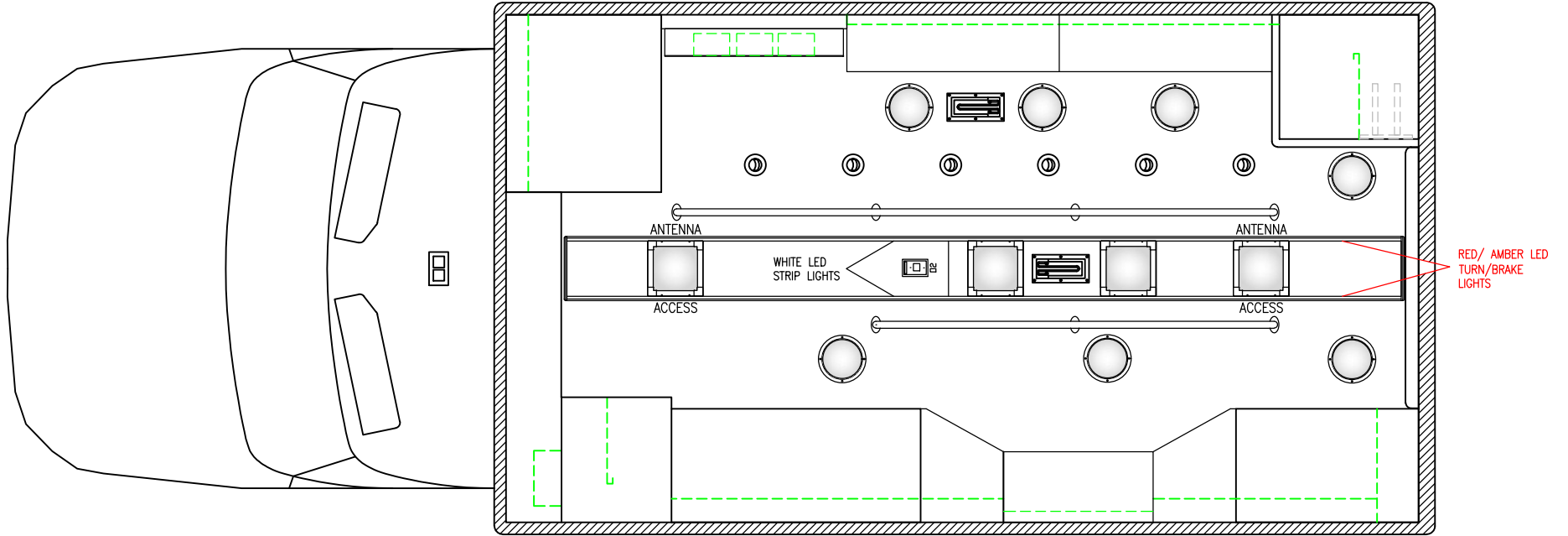

DETAILS ARE CONCEPTUAL ONLY LAYOUT AND ALL DIMENSIONS ARE APPROXIMATE AND SUBJECT TO MODIFICATION BY DESIGN ENGINEERING.

PROPRIETARY AND CONFIDENTIAL  
THIS INFORMATION CONTAINED IN THIS DRAWING IS THE SOLE PROPERTY OF ROAD RESCUE ANY REPRODUCTION IN PART OR AS A WHOLE WITHOUT THE WRITTEN PERMISSION OF ROAD RESCUE IS PROHIBITED.

|  |                    |  |            |                                  |       |               |            |  |
|--|--------------------|--|------------|----------------------------------|-------|---------------|------------|--|
| <b>Road Rescue</b>                                     |                    | 2737 N. Forsyth Rd.<br>Winter Park, FL 32792 |            | <h2>OVERHEAD CEILING DETAIL</h2> |       |               | BID NUMBER |  |
| www.roadrescue.com PHONE 800-932-7077 FAX 800-513-2688 |                    |  |            |                                  |       |               |            |  |
| DRAWN BY<br>GDG  | DATE<br>12/06/2022 | REVISION 1                                   | REVISION 2 | REVISION 3                       | SCALE | SHEET 9 OF 10 |            |  |

NOTE: THIS DRAWING IS SUBJECT TO CHANGE PENDING ROAD RESCUE PRODUCTION ENGINEERING APPROVAL. ©ROAD RESCUE ALL RIGHTS RESERVED.



**Road Rescue**  
Seamless Performance. Enlightened Design.

# ROAD RESCUE EMERGENCY VEHICLES E-450 ULTRAMEDIC // WALK-THROUGH

DEALER SIGNATURE



BLACK  
POLYURETHANE COATED

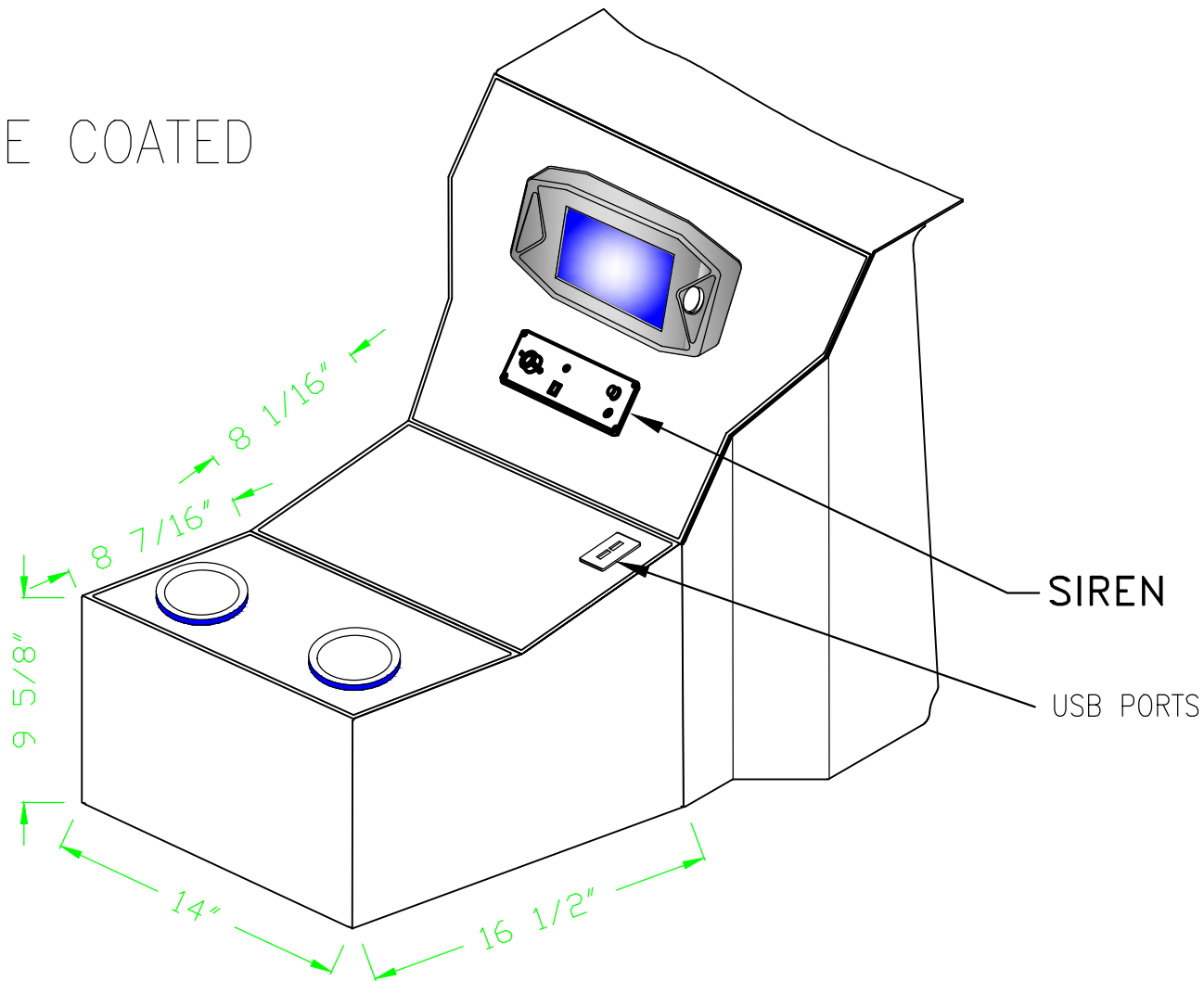

DETAILS ARE CONCEPTUAL ONLY. LAYOUT AND ALL DIMENSIONS ARE APPROXIMATE AND SUBJECT TO MODIFICATION BY DESIGN ENGINEERING.

PROPRIETARY AND CONFIDENTIAL  
THIS INFORMATION CONTAINED IN THIS DRAWING IS THE SOLE PROPERTY OF ROAD RESCUE ANY REPRODUCTION IN PART OR AS A WHOLE WITHOUT THE WRITTEN PERMISSION OF ROAD RESCUE IS PROHIBITED.

**Road Rescue**

2737 N. Forsyth Rd.  
Winter Park, FL 32792

www.roadrescue.com PHONE 800-932-7077 FAX 800-513-2688

## CONSOLE CONFIGURATION

BID NUMBER

DRAWN BY

DATE

REVISION 1

REVISION 2

REVISION 3

SCALE

SHEET

OF 10



633973



NOTE: THIS DRAWING IS SUBJECT TO CHANGE PENDING ROAD RESCUE PRODUCTION ENGINEERING APPROVAL. © ROAD RESCUE ALL RIGHTS RESERVED.