

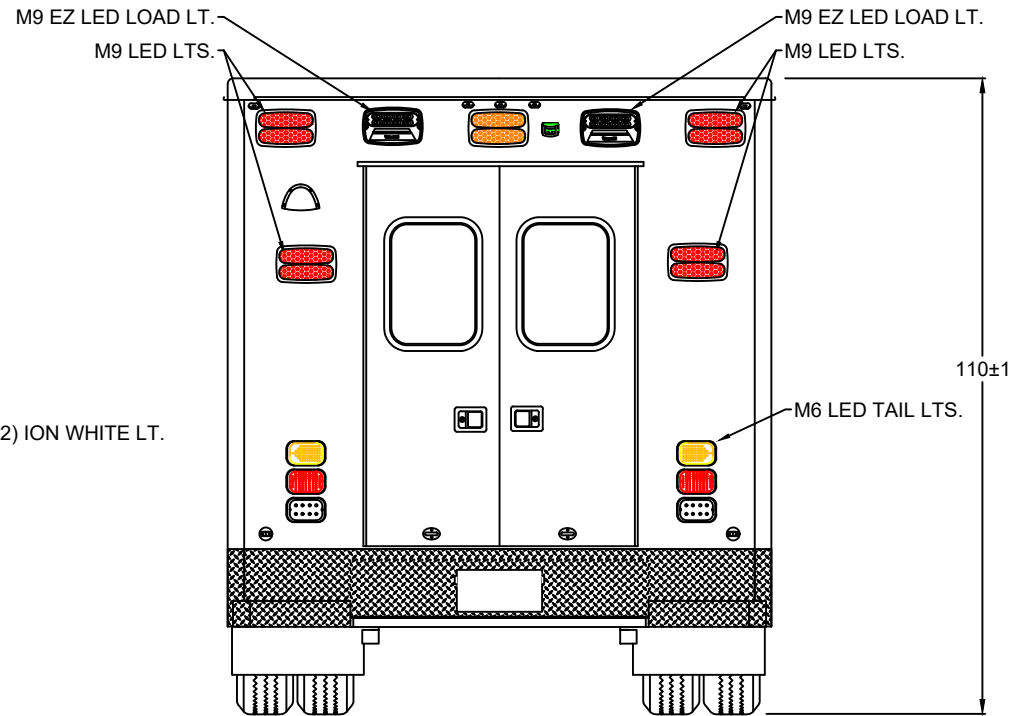

In Service for Life<sup>SM</sup>

# EEV DEMO FORD METROMEDIC 2022

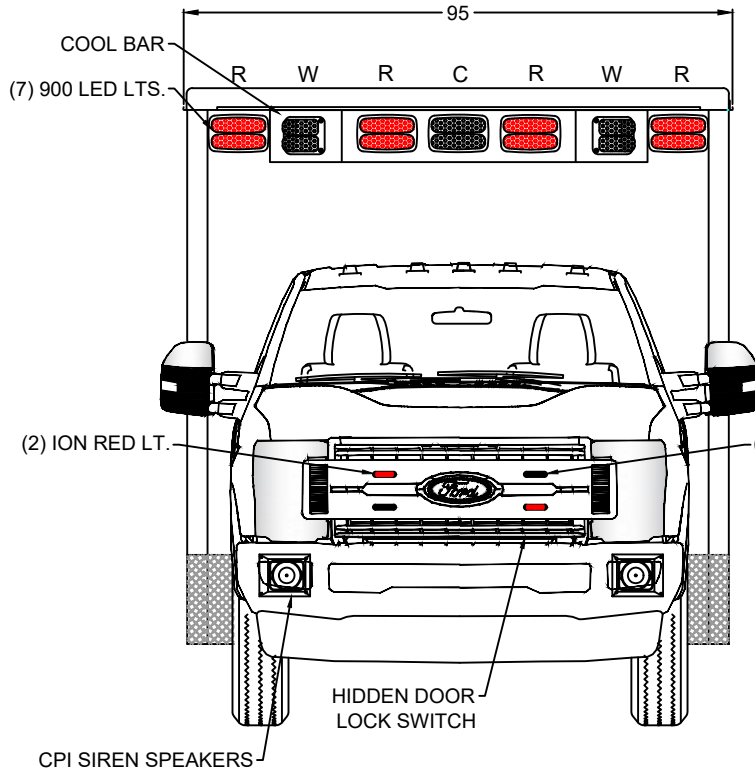

DOOR NO.	INTERIOR DIMENSIONS			NOTES	DOOR NO.	DOOR JAM OPENING		MISC. NOTES	PROPRIETARY AND CONFIDENTIAL THIS INFORMATION CONTAINED IN THIS DRAWING IS THE SOLE PROPERTY OF ROAD RESCUE ANY REPRODUCTION IN PART OR AS A WHOLE WITHOUT THE WRITTEN PERMISSION OF ROAD RESCUE IS PROHIBITED.
	HEIGHT	WIDTH	DEPTH			HEIGHT	WIDTH		
									DETAILS ARE CONCEPTUAL ONLY. LAYOUT AND ALL DIMENSIONS ARE APPROXIMATE AND SUBJECT TO MODIFICATION BY DESIGN ENGINEERING.

**Road Rescue** 2737 N. FORSYTH ROAD  
WINTER PARK, FL 32792

www.roadrescue.com PHONE 800-932-7077 FAX 800-513-2688

DRAWN BY	DATE	REVISION 1	REVISION 2	REVISION 3	SCALE
NP-DM	12/19/23				

## FRONT REAR EXTERIOR DETAIL

BID NUMBER

CA166812

NOTE: THIS DRAWING IS SUBJECT TO CHANGE PENDING ROAD RESCUE PRODUCTION ENGINEERING APPROVAL. ©ROAD RESCUE ALL RIGHTS RESERVED.



# EEV DEMO FORD METROMEDIC 2022

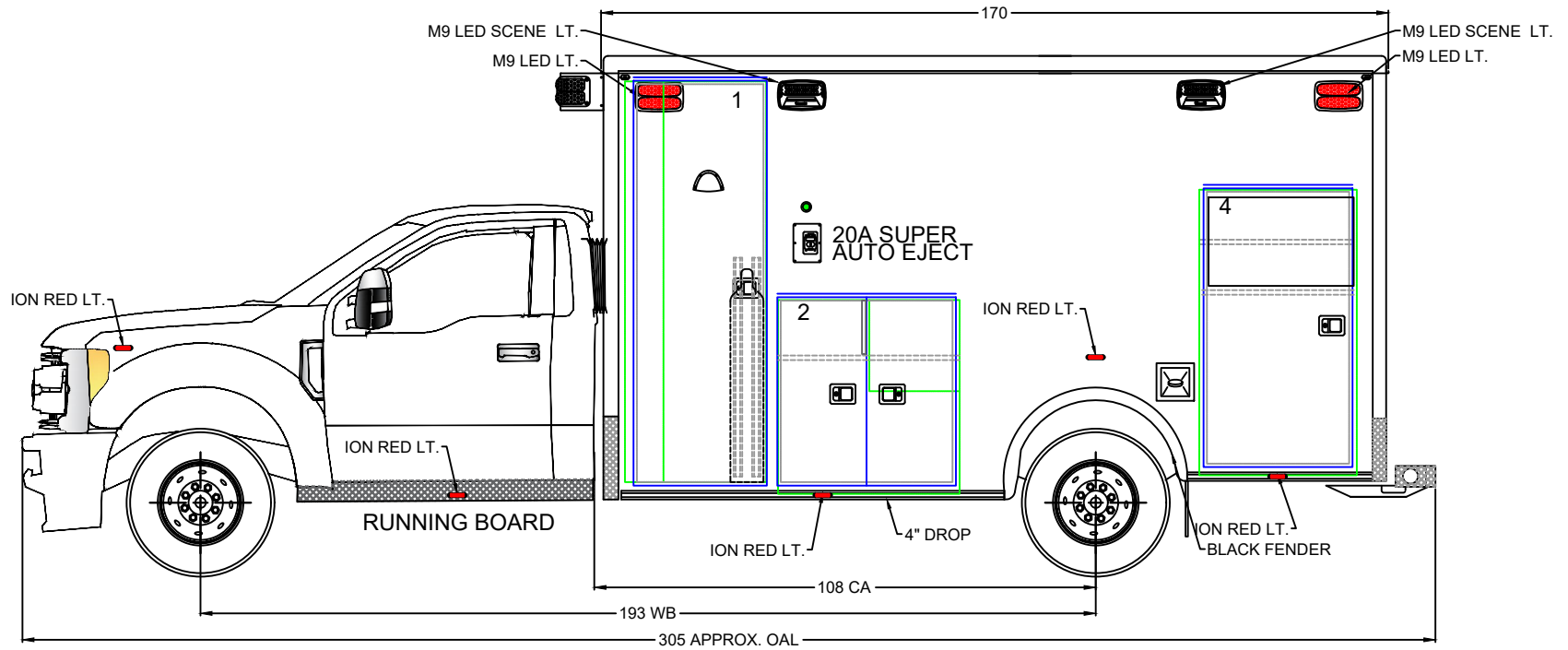

DETAILS ARE CONCEPTUAL ONLY.  
LAYOUT AND ALL DIMENSIONS ARE APPROXIMATE AND  
SUBJECT TO MODIFICATION BY DESIGN ENGINEERING.

DOOR INTERIOR DIMENSIONS				DOOR DOOR JAM OPENING				MISC. NOTES	PROPRIETARY AND CONFIDENTIAL THIS INFORMATION CONTAINED IN THIS DRAWING IS THE SOLE PROPERTY OF ROAD RESCUE ANY REPRODUCTION IN PART OR AS A WHOLE WITHOUT THE WRITTEN PERMISSION OF ROAD RESCUE IS PROHIBITED.
NO.	HEIGHT	WIDTH	DEPTH	NO.	HEIGHT	WIDTH	DEPTH		
4	61.50	34.00	17.00	4	58.50	30.50			
2	41.75	39.25	17.00	2	39.00	37.00			
1	86.50	30.50	17.00	1	85.75	27.25			

**Road Rescue** 2737 N. FORSYTH ROAD  
WINTER PARK, FL 32792

www.roadrescue.com PHONE 800-932-7077 FAX 800-513-2688

DRAWN BY NP-DM DATE 12/19/23 REVISION 1 REVISION 2 REVISION 3 SCALE

## LEFT EXTERIOR DETAIL

BID NUMBER

CA166812

NOTE: THIS DRAWING IS SUBJECT TO CHANGE PENDING ROAD RESCUE PRODUCTION ENGINEERING APPROVAL. ©ROAD RESCUE ALL RIGHTS RESERVED.

# EEV DEMO FORD METROMEDIC 2022

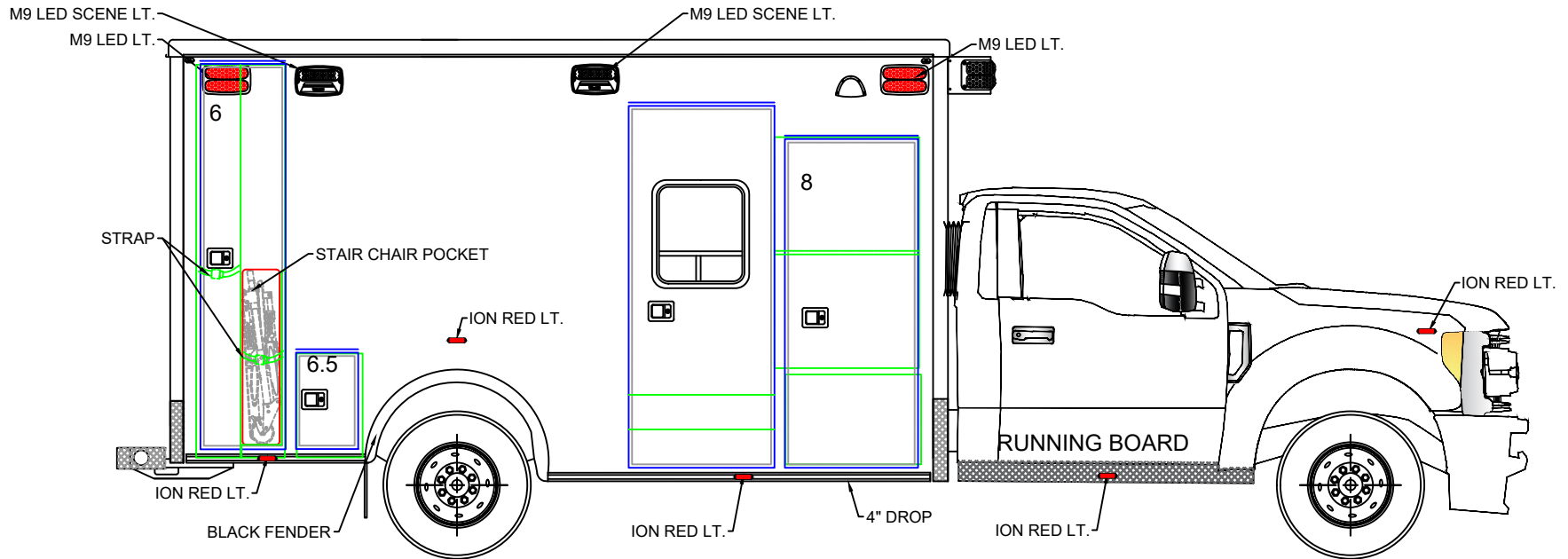

DETAILS ARE CONCEPTUAL ONLY.  
LAYOUT AND ALL DIMENSIONS ARE APPROXIMATE AND  
SUBJECT TO MODIFICATION BY DESIGN ENGINEERING.

DOOR NO.	INTERIOR DIMENSIONS			DOOR NO.	DOOR JAM OPENING			MISC. NOTES	PROPRIETARY AND CONFIDENTIAL THIS INFORMATION CONTAINED IN THIS DRAWING IS THE SOLE PROPERTY OF ROAD RESCUE ANY REPRODUCTION IN PART OR AS A WHOLE WITHOUT THE WRITTEN PERMISSION OF ROAD RESCUE IS PROHIBITED.
	HEIGHT	WIDTH	DEPTH		HEIGHT	WIDTH	DEPTH		
8				8	69.50	27.25			
8.5	19.50	29.25	19.00						
6.5	22.50	14.25	17.00	6.5	19.25	12.00			
6	85.00	19.00	20.00	6	81.75	17.00			



**Road Rescue** 2737 N. FORSYTH ROAD  
WINTER PARK, FL 32792

www.roadrescue.com PHONE 800-932-7077 FAX 800-513-2688

DRAWN BY NP-DM DATE 12/19/23 REVISION 1 REVISION 2 REVISION 3 SCALE

## RIGHT EXTERIOR DETAIL

BID NUMBER

 CA166812 

NOTE: THIS DRAWING IS SUBJECT TO CHANGE PENDING ROAD RESCUE PRODUCTION ENGINEERING APPROVAL. ©ROAD RESCUE ALL RIGHTS RESERVED.

# EEV DEMO FORD METROMEDIC 2022

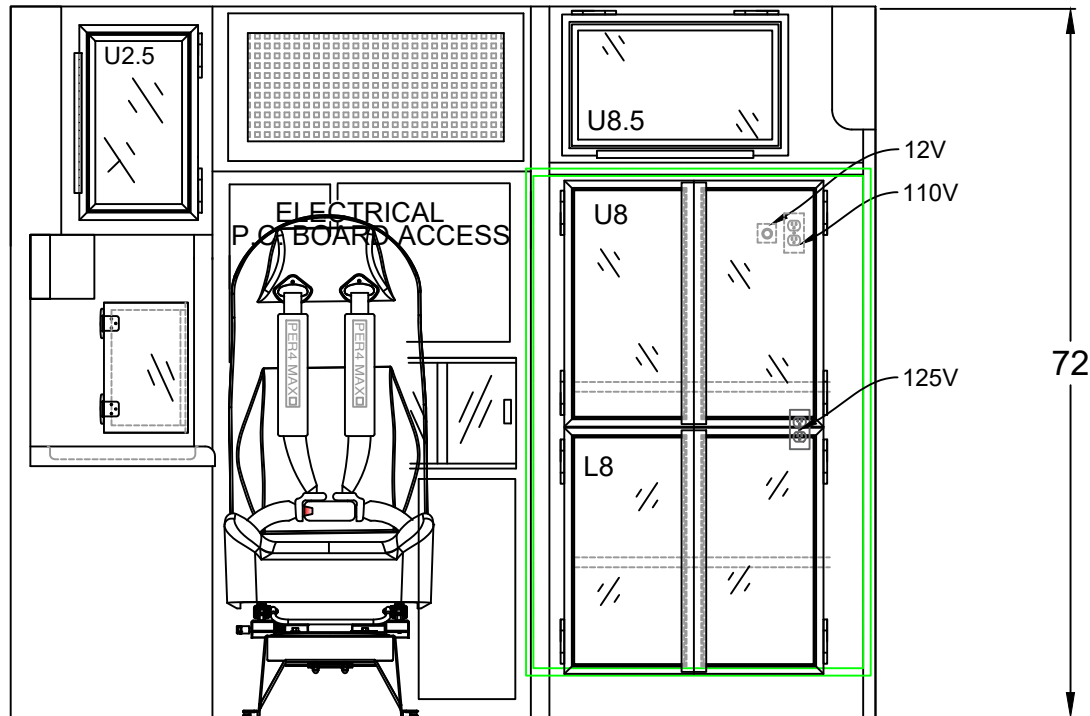

DOOR NO.	CABINET DIMENSIONS			MISC. NOTES	NOTES:	PROPRIETARY AND CONFIDENTIAL THIS INFORMATION CONTAINED IN THIS DRAWING IS THE SOLE PROPERTY OF ROAD RESCUE ANY REPRODUCTION IN PART OR AS A WHOLE WITHOUT THE WRITTEN PERMISSION OF ROAD RESCUE IS PROHIBITED.
	HEIGHT	WIDTH	DEPTH			
U8	24.50	33.50	30.50		DETAILS ARE CONCEPTUAL ONLY. LAYOUT AND ALL DIMENSIONS ARE APPROXIMATE AND SUBJECT TO MODIFICATION BY DESIGN ENGINEERING.	
L8	24.50	33.50	30.50			
U8.5	14.00	22.00	25.00			

**Road Rescue** 2737 N. FORSYTH ROAD  
WINTER PARK, FL 32792

## FRONT INTERIOR DETAIL

BID NUMBER

www.roadrescue.com PHONE 800-932-7077 FAX 800-513-2688  
DRAWN BY NP-DM DATE 12/19/23 REVISION 1

REVISION 2 REVISION 3 SCALE SHEET 4 OF 9

 CA166812 

# EEV DEMO FORD METROMEDIC 2022

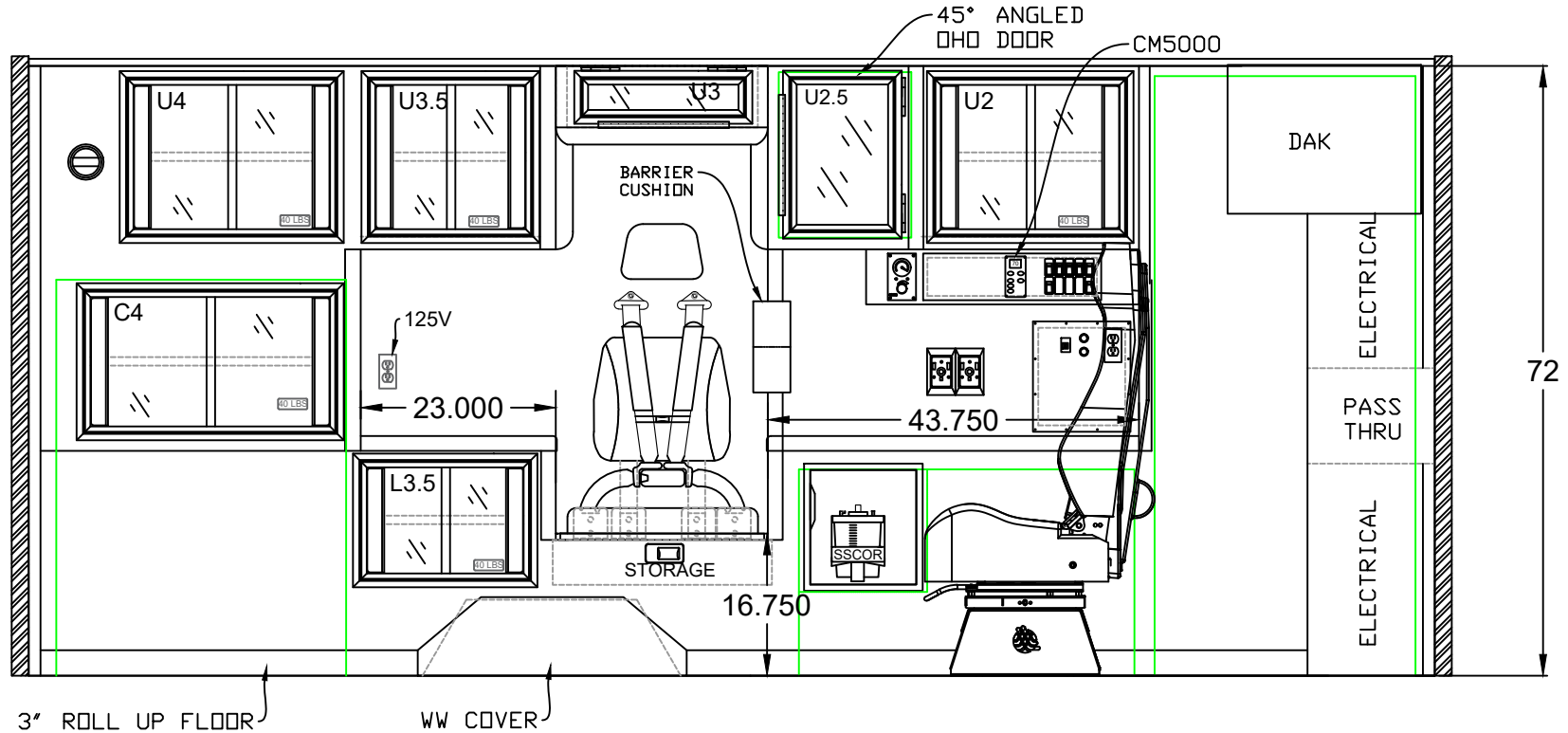

DOOR NO.	CABINET DIMENSIONS			DOOR NO.	CABINET DIMENSIONS		
	HEIGHT	WIDTH	DEPTH		HEIGHT	WIDTH	DEPTH
C4	17.00	30.00	IS/OS	U2	18.75	24.25	16.00
U4	18.75	26.25	18.25	L3.5	14.25	20.25	18.25
U3.5	18.75	20.25	18.25	CPR	4.50	23.50	18.25
U2.5	19.50	18.00	16.00	U3	5.75	21.00	4.00



NOTES:

DETAILS ARE CONCEPTUAL ONLY. LAYOUT AND ALL DIMENSIONS ARE APPROXIMATE AND SUBJECT TO MODIFICATION BY DESIGN ENGINEERING.

PROPRIETARY AND CONFIDENTIAL  
THIS INFORMATION CONTAINED IN THIS DRAWING IS THE SOLE PROPERTY OF ROAD RESCUE ANY REPRODUCTION IN PART OR AS A WHOLE WITHOUT THE WRITTEN PERMISSION OF ROAD RESCUE IS PROHIBITED.

**Road Rescue** 2737 N. FORSYTH ROAD  
WINTER PARK, FL 32792

## LEFT INTERIOR DETAIL

BID NUMBER  
 CA166812 

www.roadrescue.com PHONE 800-932-7077 FAX 800-513-2688  
DRAWN BY NP-DM DATE 12/19/23 REVISION 1 REVISION 2 REVISION 3 SCALE SHEET 5 OF 9

# EEV DEMO FORD METROMEDIC 2022

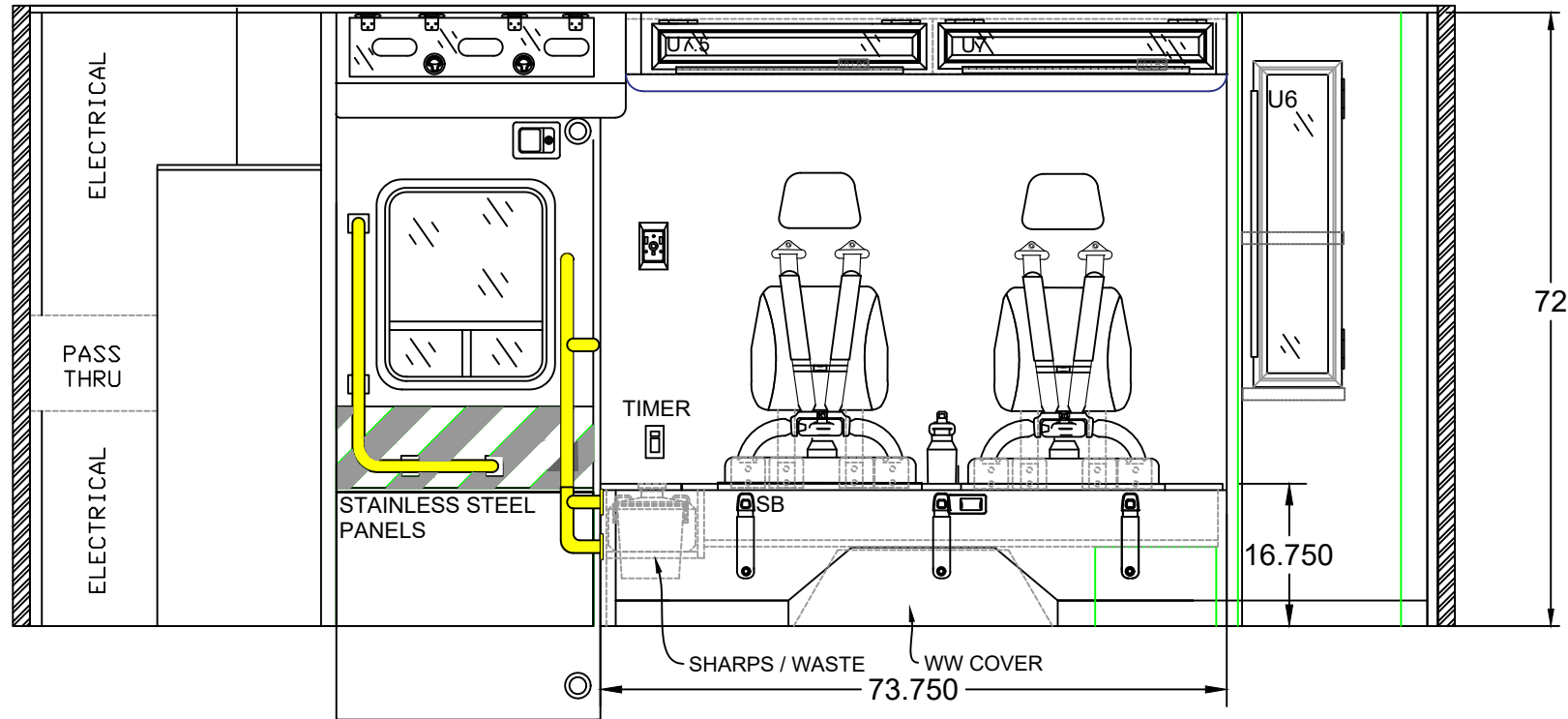

50" AISLE

DOOR NO.	CABINET DIMENSIONS			DOOR NO.	CABINET DIMENSIONS			NOTES:	PROPRIETARY AND CONFIDENTIAL THIS INFORMATION CONTAINED IN THIS DRAWING IS THE SOLE PROPERTY OF ROAD RESCUE ANY REPRODUCTION IN PART OR AS A WHOLE WITHOUT THE WRITTEN PERMISSION OF ROAD RESCUE IS PROHIBITED.
	HEIGHT	WIDTH	DEPTH		HEIGHT	WIDTH	DEPTH		
SB	5.75	60.50	16.75					DETAILS ARE CONCEPTUAL ONLY. LAYOUT AND ALL DIMENSIONS ARE APPROXIMATE AND SUBJECT TO MODIFICATION BY DESIGN ENGINEERING.	
U7.5	5.00	32.00	7.00						
U7	5.00	32.00	7.00						
U6	36.00	9.00	IS/OS						



**Road Rescue** 2737 N. FORSYTH ROAD  
WINTER PARK, FL 32792

www.roadrescue.com PHONE 800-932-7077 FAX 800-513-2688

DRAWN BY NP-DM DATE 12/19/23 REVISION 1

REVISION 2 REVISION 3 SCALE

## RIGHT INTERIOR DETAIL

BID NUMBER  
 CA166812 

# EEV DEMO FORD METROMEDIC 2022

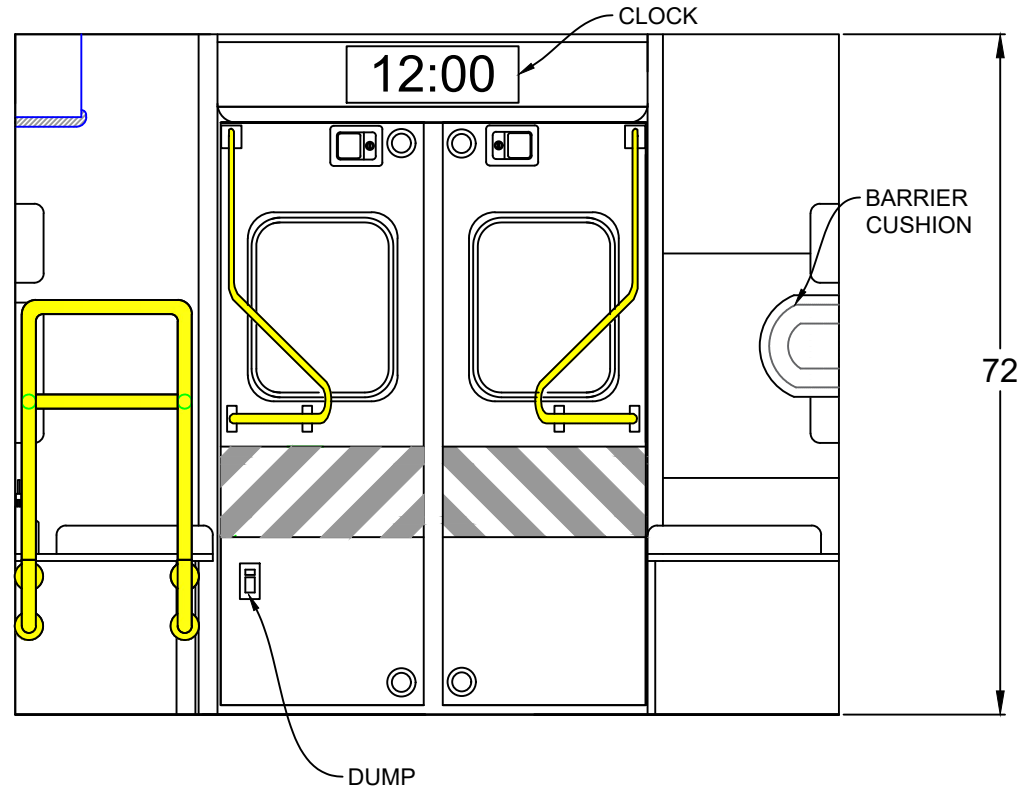

NOTES:

NOTES:

DETAILS ARE CONCEPTUAL ONLY.  
LAYOUT AND ALL DIMENSIONS ARE APPROXIMATE AND  
SUBJECT TO MODIFICATION BY DESIGN ENGINEERING.

PROPRIETARY AND  
CONFIDENTIAL  
THIS INFORMATION  
CONTAINED IN THIS  
DRAWING IS THE SOLE  
PROPERTY OF ROAD  
RESCUE ANY  
REPRODUCTION IN PART  
OR AS A WHOLE  
WITHOUT THE WRITTEN  
PERMISSION OF ROAD  
RESCUE IS PROHIBITED.

**Road Rescue** 2737 N. FORSYTH ROAD  
WINTER PARK, FL 32792

www.roadrescue.com PHONE 800-932-7077 FAX 800-513-2688

DRAWN BY NP-DM	DATE 12/19/23	REVISION 1	REVISION 2	REVISION 3	SCALE
-------------------	------------------	------------	------------	------------	-------

## REAR INTERIOR DETAIL

BID NUMBER

 CA166812 

NOTE: THIS DRAWING IS SUBJECT TO CHANGE PENDING ROAD RESCUE PRODUCTION ENGINEERING APPROVAL. ©ROAD RESCUE ALL RIGHTS RESERVED.

# EEV DEMO FORD METROMEDIC 2022

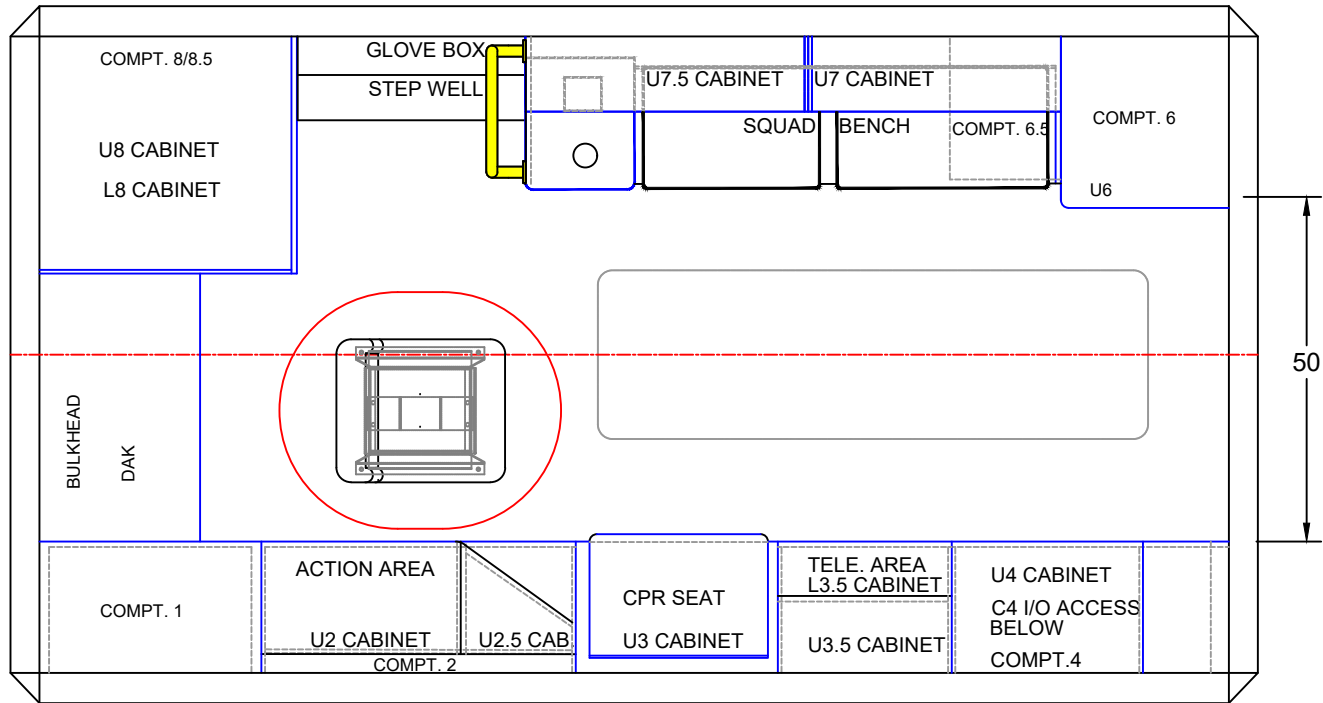

<p>NOTES:</p>	<p>NOTES:</p> <p style="font-size: small;">DETAILS ARE CONCEPTUAL ONLY. LAYOUT AND ALL DIMENSIONS ARE APPROXIMATE AND SUBJECT TO MODIFICATION BY DESIGN ENGINEERING.</p>	<p style="font-size: x-small;">PROPRIETARY AND CONFIDENTIAL THIS INFORMATION CONTAINED IN THIS DRAWING IS THE SOLE PROPERTY OF ROAD RESCUE ANY REPRODUCTION IN PART OR AS A WHOLE WITHOUT THE WRITTEN PERMISSION OF ROAD RESCUE IS PROHIBITED.</p>
---------------	--	--

<b>Road Rescue</b>	2737 N. FORSYTH ROAD WINTER PARK, FL 32792	<h2 style="margin: 0;">OVERHEAD FLOOR DETAIL</h2>	BID NUMBER
www.roadrescue.com PHONE 800-932-7077 FAX 800-513-2688	DRAWN BY NP-DM DATE 12/19/23 REVISION 1	REVISION 2 REVISION 3 SCALE	CA166812





# EEV DEMO FORD METROMEDIC 2022

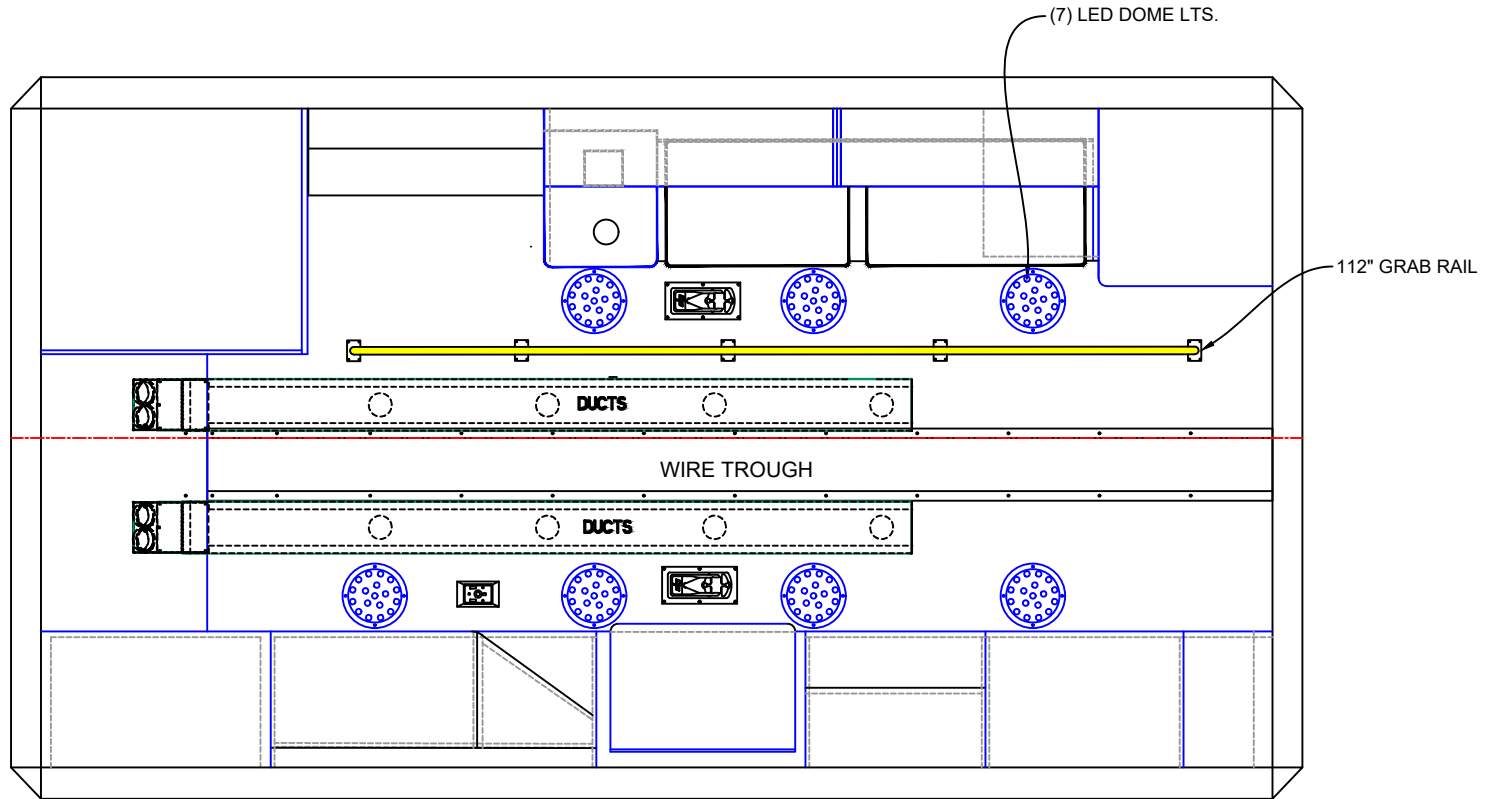

NOTES:

NOTES:

DETAILS ARE CONCEPTUAL ONLY.  
LAYOUT AND ALL DIMENSIONS ARE APPROXIMATE AND  
SUBJECT TO MODIFICATION BY DESIGN ENGINEERING.

PROPRIETARY AND  
CONFIDENTIAL  
THIS INFORMATION  
CONTAINED IN THIS  
DRAWING IS THE SOLE  
PROPERTY OF ROAD  
RESCUE ANY  
REPRODUCTION IN PART  
OR AS A WHOLE  
WITHOUT THE WRITTEN  
PERMISSION OF ROAD  
RESCUE IS PROHIBITED.

**Road Rescue** 2737 N. FORSYTH ROAD  
WINTER PARK, FL 32792

www.roadrescue.com PHONE 800-932-7077 FAX 800-513-2688

DRAWN BY NP-DM	DATE 12/19/23	REVISION 1	REVISION 2	REVISION 3	SCALE
-------------------	------------------	------------	------------	------------	-------

## OVERHEAD CEILING DETAIL

BID NUMBER

CA166812

NOTE: THIS DRAWING IS SUBJECT TO CHANGE PENDING ROAD RESCUE PRODUCTION ENGINEERING APPROVAL. ©ROAD RESCUE ALL RIGHTS RESERVED.