



ROAD RESCUE EMERGENCY VEHICLES E-450 ULTRAMEDIC // WALK-THROUGH



DO NOT CUT HOLES FOR COMPARTMENT LIGHTING

FL - INDICATES A FULL HEIGHT FLEXIBLE LIGHTING STRIP

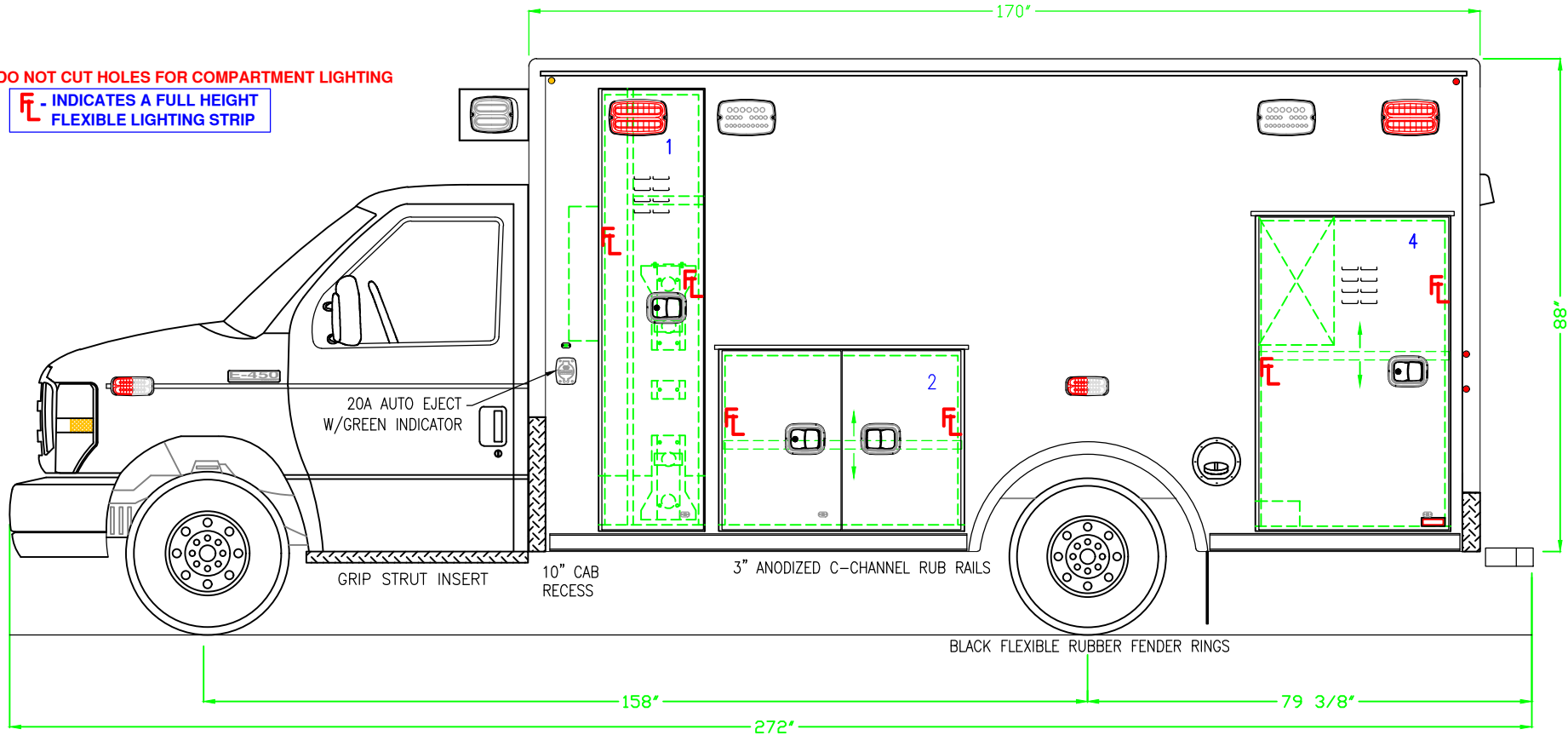

DOOR NO.	INTERIOR DIMENSIONS			NOTES	NOTES:	PROPRIETARY AND CONFIDENTIAL THIS INFORMATION CONTAINED IN THIS DRAWING IS THE SOLE PROPERTY OF ROAD RESCUE ANY REPRODUCTION IN PART OR AS A WHOLE WITHOUT THE WRITTEN PERMISSION OF ROAD RESCUE IS PROHIBITED.
	HEIGHT	WIDTH	DEPTH			
1	78.00"	19.37"	22.12" TOP, 21.31" BOTTOM	FIXED DIVIDER & SHELF, O2 STORAGE	DETAILS ARE CONCEPTUAL ONLY. LAYOUT AND ALL DIMENSIONS ARE APPROXIMATE AND SUBJECT TO MODIFICATION BY DESIGN ENGINEERING.	
2	31.37"	43.87"	19.25"	(1) ADJ. SHELF		
4	55.50"	35.00"	19.25"	(1) ADJ. SHELF		

Road Rescue
2737 N. Forsyth Rd.
Winter Park, FL 32792
www.roadrescue.com PHONE 800-932-7077 FAX 800-513-2688

STREETSIDE EXTERIOR DETAIL

BID NUMBER

682176

DRAWN BY: GDG
DATE: 10/10/2023
REVISION 1
REVISION 2
REVISION 3
SCALE

SHEET 1 OF 10



ROAD RESCUE EMERGENCY VEHICLES E-450 ULTRAMEDIC // WALK-THROUGH

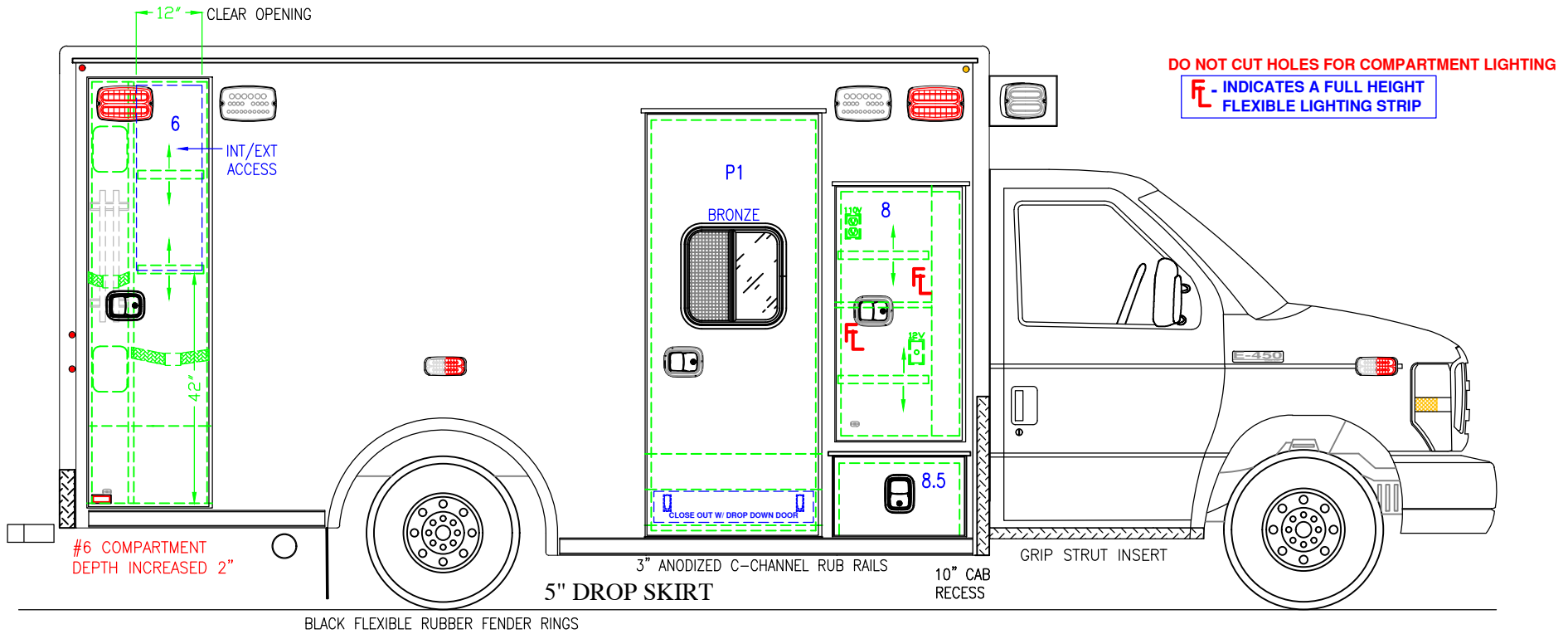

DOOR NO.	INTERIOR DIMENSIONS			NOTES	DOOR NO.	DOOR DIMENSIONS		MISC. NOTES
	HEIGHT	WIDTH	DEPTH			HEIGHT	WIDTH	
6	78.00"	22.75"	21.87" TOP, 21.18" BOTTOM	(1) FIXED DIV., (2) ADJ. SHELVES	8	46.31"	23.50"	RIGHT STACK/ALS ACCESS
8.5	13.50"	24.37"	20.87"	BATTERY DRAWER FOR (3) BATTERIES	P1	77.00"	30.06"	18"x18" SLIDING BRONZE WINDOW
DETAILS ARE CONCEPTUAL ONLY. LAYOUT AND ALL DIMENSIONS ARE APPROXIMATE AND SUBJECT TO MODIFICATION BY DESIGN ENGINEERING.								

PROPRIETARY AND CONFIDENTIAL
THIS INFORMATION CONTAINED IN THIS DRAWING IS THE SOLE PROPERTY OF ROAD RESCUE ANY REPRODUCTION IN PART OR AS A WHOLE WITHOUT THE WRITTEN PERMISSION OF ROAD RESCUE IS PROHIBITED.

Road Rescue 2737 N. Forsyth Rd. Winter Park, FL 32792
 www.roadrescue.com PHONE 800-932-7077 FAX 800-513-2688
 DRAWN BY GDG DATE 10/10/2023 REVISION 1 11/17/2023

CURBSIDE EXTERIOR DETAIL

BID NUMBER
 682176



ROAD RESCUE EMERGENCY VEHICLES E-450 ULTRAMEDIC // WALK-THROUGH

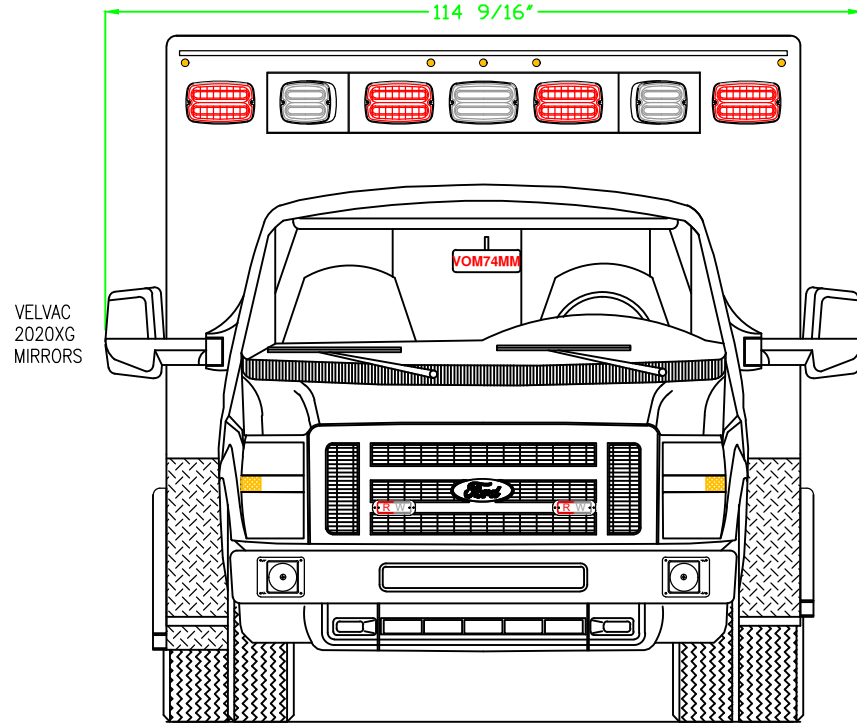
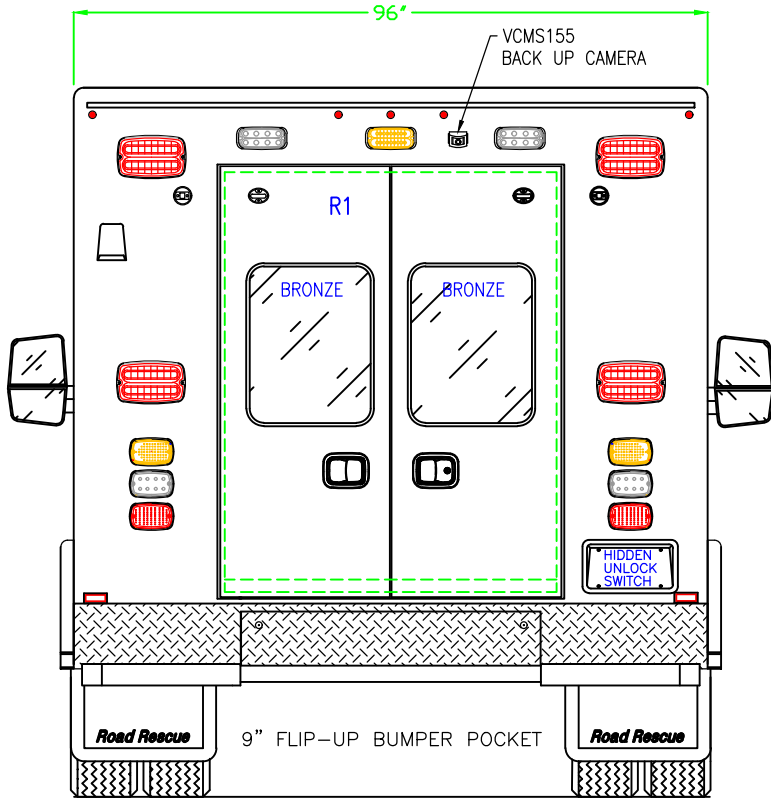

DOOR NO.	DOOR JAM OPENING		NOTES
	HEIGHT	WIDTH	
R1	61.44"	50.25"	FIXED BRONZE WINDOWS 18" X 24"

NOTES:

DETAILS ARE CONCEPTUAL ONLY.
LAYOUT AND ALL DIMENSIONS ARE APPROXIMATE AND
SUBJECT TO MODIFICATION BY DESIGN ENGINEERING.

PROPRIETARY AND CONFIDENTIAL
THIS INFORMATION CONTAINED IN THIS DRAWING IS THE SOLE PROPERTY OF ROAD RESCUE ANY REPRODUCTION IN PART OR AS A WHOLE WITHOUT THE WRITTEN PERMISSION OF ROAD RESCUE IS PROHIBITED.

Road Rescue 2737 N. Forsyth Rd.
Winter Park, FL 32792

www.roadrescue.com PHONE 800-932-7077 FAX 800-513-2688

DRAWN BY: GDG DATE: 10/10/2023 REVISION 1

FRONT & REAR EXTERIOR DETAIL

REVISION 2 REVISION 3 SCALE

SHEET 3 OF 10

BID NUMBER

682176

ROAD RESCUE EMERGENCY VEHICLES E-450 ULTRAMEDIC // WALK-THROUGH

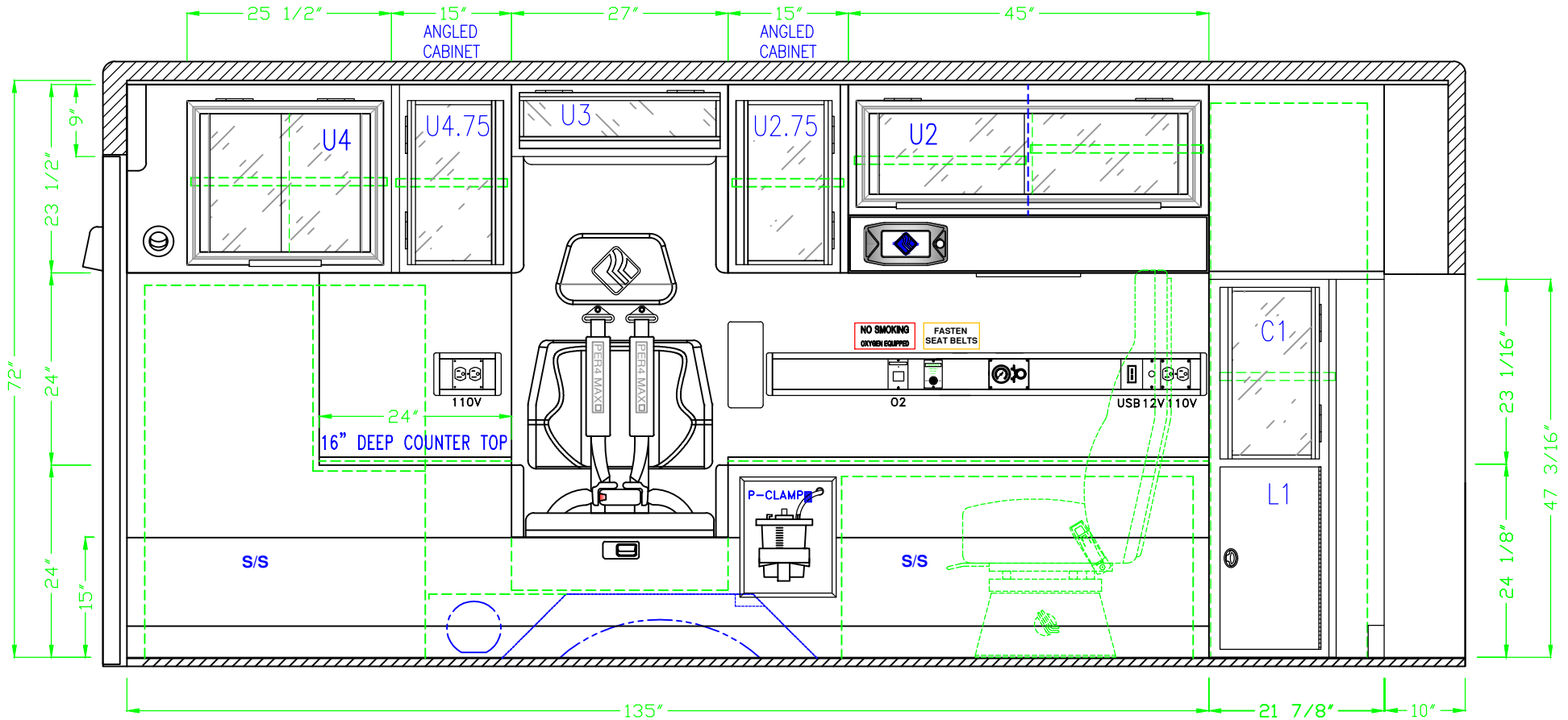

DOOR NO.	INTERIOR DIMENSIONS			NOTES	DOOR NO.	EXTERIOR DIMENSIONS			NOTES
	HEIGHT	WIDTH	DEPTH			HEIGHT	WIDTH	DEPTH	
C1	23.00"	21.49"	16.50"	OHO DOOR, (1) ADJ. SHELF	U4	23.25"	25.25"	15.00"	SLIDING POLY DOORS, (1) ADJ. SHELF, RESTOCKING
L1	24.00"	21.49"	16.50"	SINGLE ALUM. DOOR, LOCKING	DETAILS ARE CONCEPTUAL ONLY. LAYOUT AND DIMENSIONS ARE APPROXIMATE AND SUBJECT TO MODIFICATION BY DESIGN ENGINEERING				
U2	16.00"	44.75"	15.00"	SLIDING POLY DOORS, FIXED DIV. (2) ADJ. SHELVES, RESTOCKING					
U3	8.75"	26.75"	10.75"	OHO DOOR, RESTOCKING					

PROPRIETARY AND CONFIDENTIAL
THIS INFORMATION CONTAINED IN THIS DRAWING IS THE SOLE PROPERTY OF ROAD RESCUE ANY REPRODUCTION IN PART OR AS A WHOLE WITHOUT THE WRITTEN PERMISSION OF ROAD RESCUE IS PROHIBITED.

Road Rescue 2737 N. Forsyth Rd. Winter Park, FL 32792
www.roadrescue.com PHONE 800-932-7077 FAX 800-513-2688

STREETSIDE INTERIOR DETAIL

BID NUMBER **682176**

DRAWN BY: GDG DATE: 10/10/2023 REVISION 1: 11/17/2023 REVISION 2: REVISION 3: SCALE: SHEET 4 OF 10

NOTE: THIS DRAWING IS SUBJECT TO CHANGE PENDING ROAD RESCUE PRODUCTION ENGINEERING APPROVAL. ©ROAD RESCUE ALL RIGHTS RESERVED.

ROAD RESCUE EMERGENCY VEHICLES E-450 ULTRAMEDIC // WALK-THROUGH

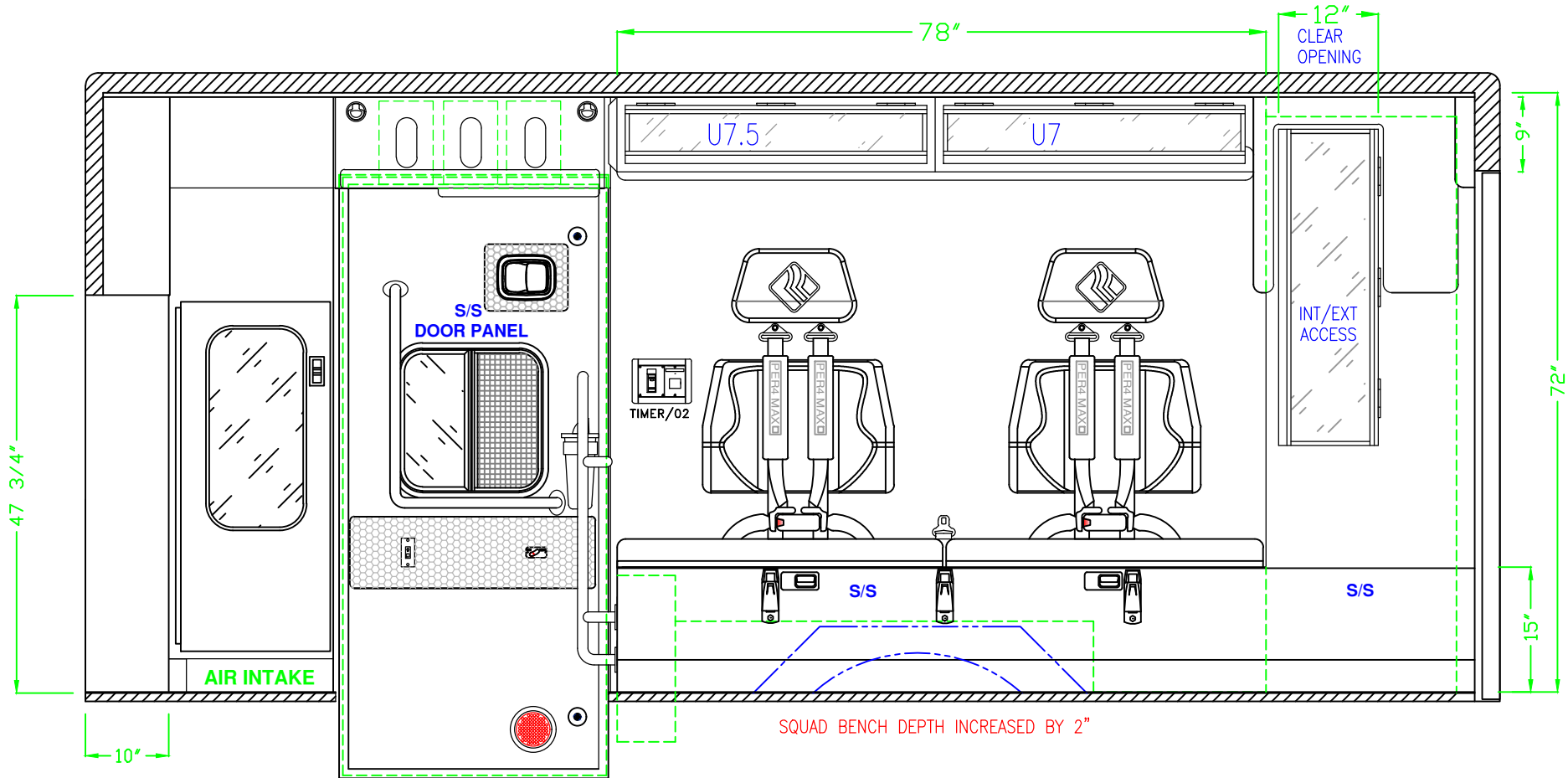

DOOR NO.	INTERIOR DIMENSIONS			NOTES
	HEIGHT	WIDTH	DEPTH	
U7	9.00"	40.00"	8.50"	OHO FLIP UP DOOR, RESTOCKING
U7.5	9.00"	38.00"	8.50"	OHO FLIP UP DOOR, RESTOCKING



DETAILS ARE CONCEPTUAL ONLY. LAYOUT AND DIMENSIONS ARE APPROXIMATE AND SUBJECT TO MODIFICATION BY DESIGN ENGINEERING

PROPRIETARY AND CONFIDENTIAL
THIS INFORMATION CONTAINED IN THIS DRAWING IS THE SOLE PROPERTY OF ROAD RESCUE ANY REPRODUCTION IN PART OR AS A WHOLE WITHOUT THE WRITTEN PERMISSION OF ROAD RESCUE IS PROHIBITED.

Road Rescue 2737 N. Forsyth Rd.
Winter Park, FL 32792
www.roadrescue.com PHONE 800-932-7077 FAX 800-513-2688

DRAWN BY GDG DATE 10/10/2023 REVISION 1 REVISION 2 REVISION 3 SCALE

CURBSIDE INTERIOR DETAIL

BID NUMBER  **682176** 

ROAD RESCUE EMERGENCY VEHICLES E-450 ULTRAMEDIC // WALK-THROUGH

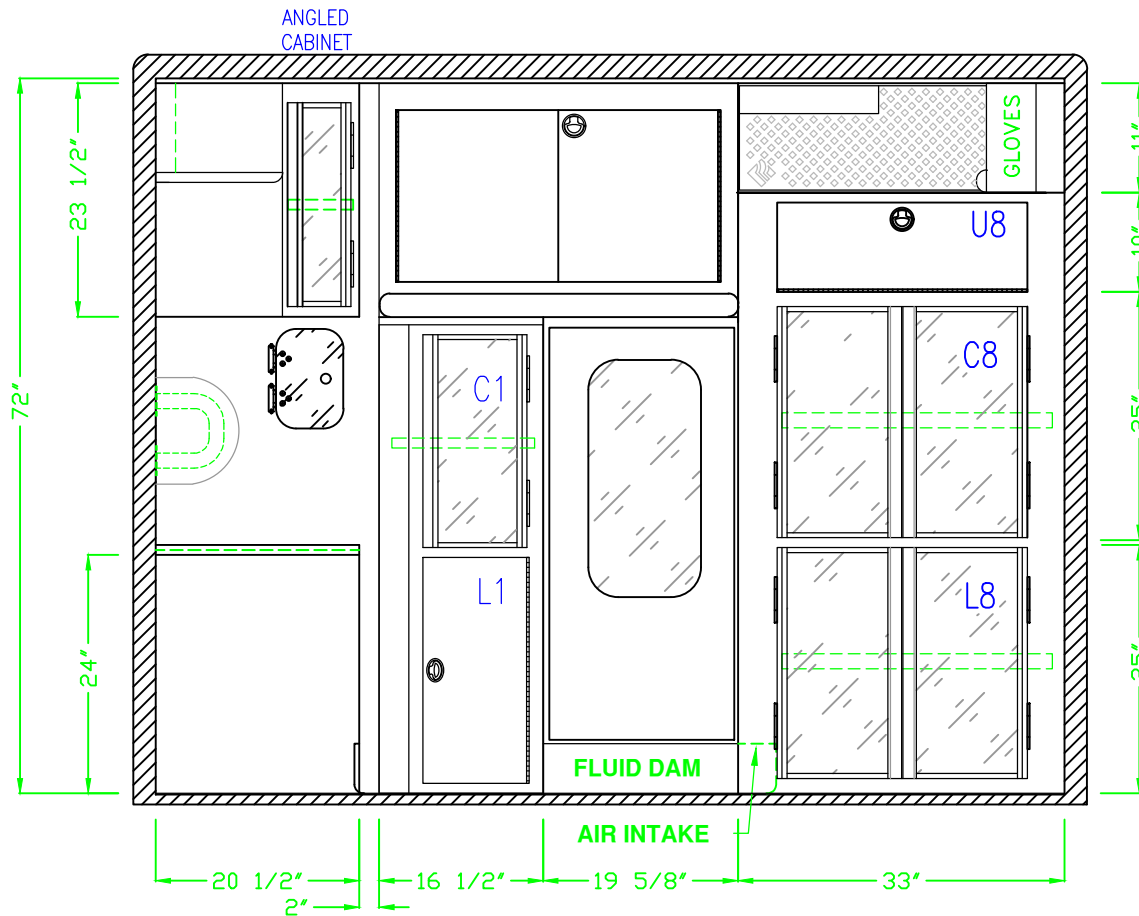

DOOR NO.	CABINET DIMENSIONS			MISC. NOTES
	HEIGHT	WIDTH	DEPTH	
U8	10.00"	28.00"	20.00"	SINGLE SOLID ALUM, LOCKING LATCH
C8	25.00"	28.00"	20.00"	OHO DOORS, (1) ADJ. SHELF
L8	25.00"	28.00"	20.00"	OHO DOORS, (1) ADJ. SHELF

NOTES:

DETAILS ARE CONCEPTUAL ONLY. LAYOUT AND DIMENSIONS ARE APPROXIMATE AND SUBJECT TO MODIFICATION BY DESIGN ENGINEERING

PROPRIETARY AND CONFIDENTIAL
THIS INFORMATION CONTAINED IN THIS DRAWING IS THE SOLE PROPERTY OF ROAD RESCUE ANY REPRODUCTION IN PART OR AS A WHOLE WITHOUT THE WRITTEN PERMISSION OF ROAD RESCUE IS PROHIBITED.

Road Rescue

2737 N. Forsyth Rd.
Winter Park, FL 32792

FRONT INTERIOR DETAIL

BID NUMBER



www.roadrescue.com PHONE 800-932-7077 FAX 800-513-2688

DRAWN BY: GDG DATE: 10/10/2023 REVISION 1: 11/17/2023

REVISION 2 REVISION 3

SCALE

SHEET 6 OF 10

 **682176** 

ROAD RESCUE EMERGENCY VEHICLES E-450 ULTRAMEDIC // WALK-THROUGH

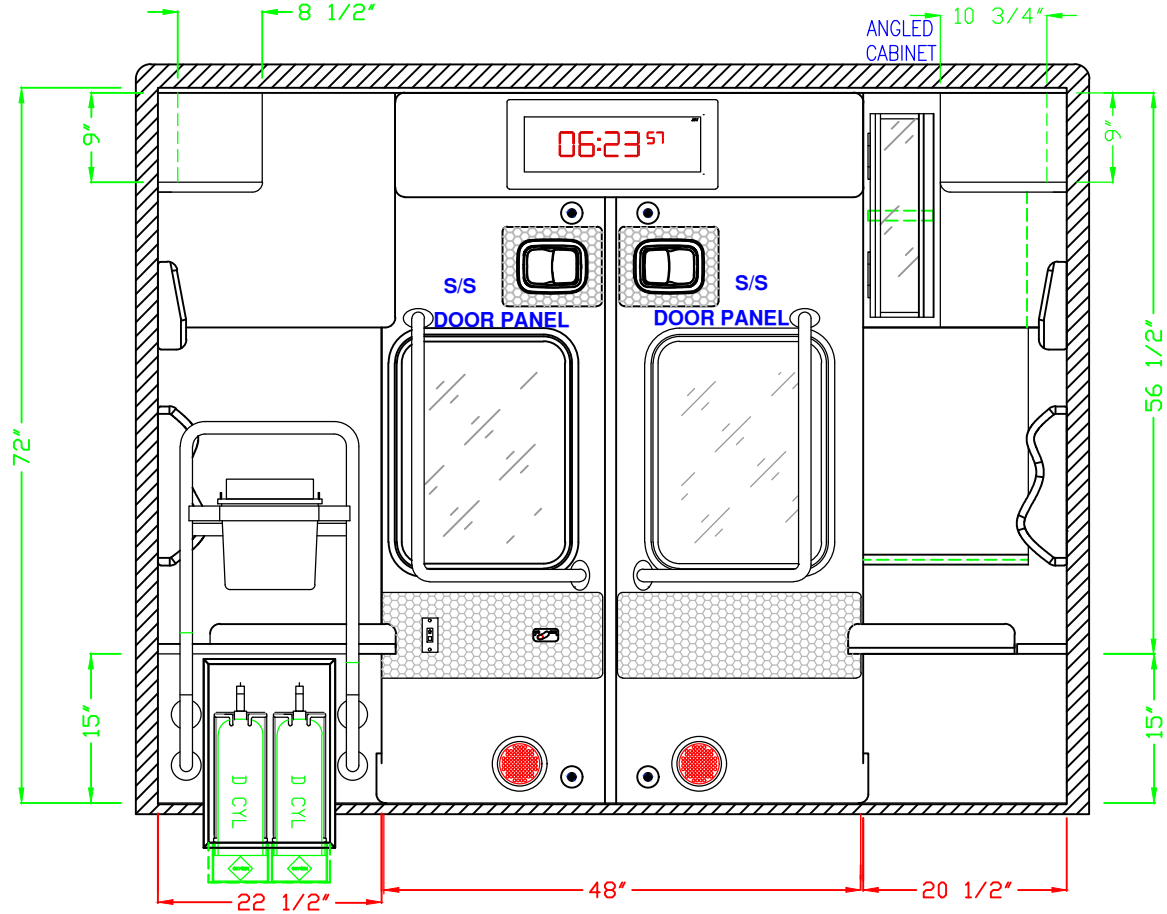



DETAILS ARE CONCEPTUAL ONLY. LAYOUT AND DIMENSIONS ARE APPROXIMATE AND SUBJECT TO MODIFICATION BY DESIGN ENGINEERING

PROPRIETARY AND CONFIDENTIAL
THIS INFORMATION CONTAINED IN THIS DRAWING IS THE SOLE PROPERTY OF ROAD RESCUE ANY REPRODUCTION IN PART OR AS A WHOLE WITHOUT THE WRITTEN PERMISSION OF ROAD RESCUE IS PROHIBITED.

Road Rescue 2737 N. Forsyth Rd.
Winter Park, FL 32792
www.roadrescue.com PHONE 800-932-7077 FAX 800-513-2688

REAR INTERIOR DETAIL

BID NUMBER
 **682176** 

DRAWN BY GDG	DATE 10/10/2023	REVISION 1 11/17/2023	REVISION 2	REVISION 3	SCALE	SHEET 7 OF 10
-----------------	--------------------	--------------------------	------------	------------	-------	---------------



ROAD RESCUE EMERGENCY VEHICLES E-450 ULTRAMEDIC // WALK-THROUGH

DEALER SIGNATURE

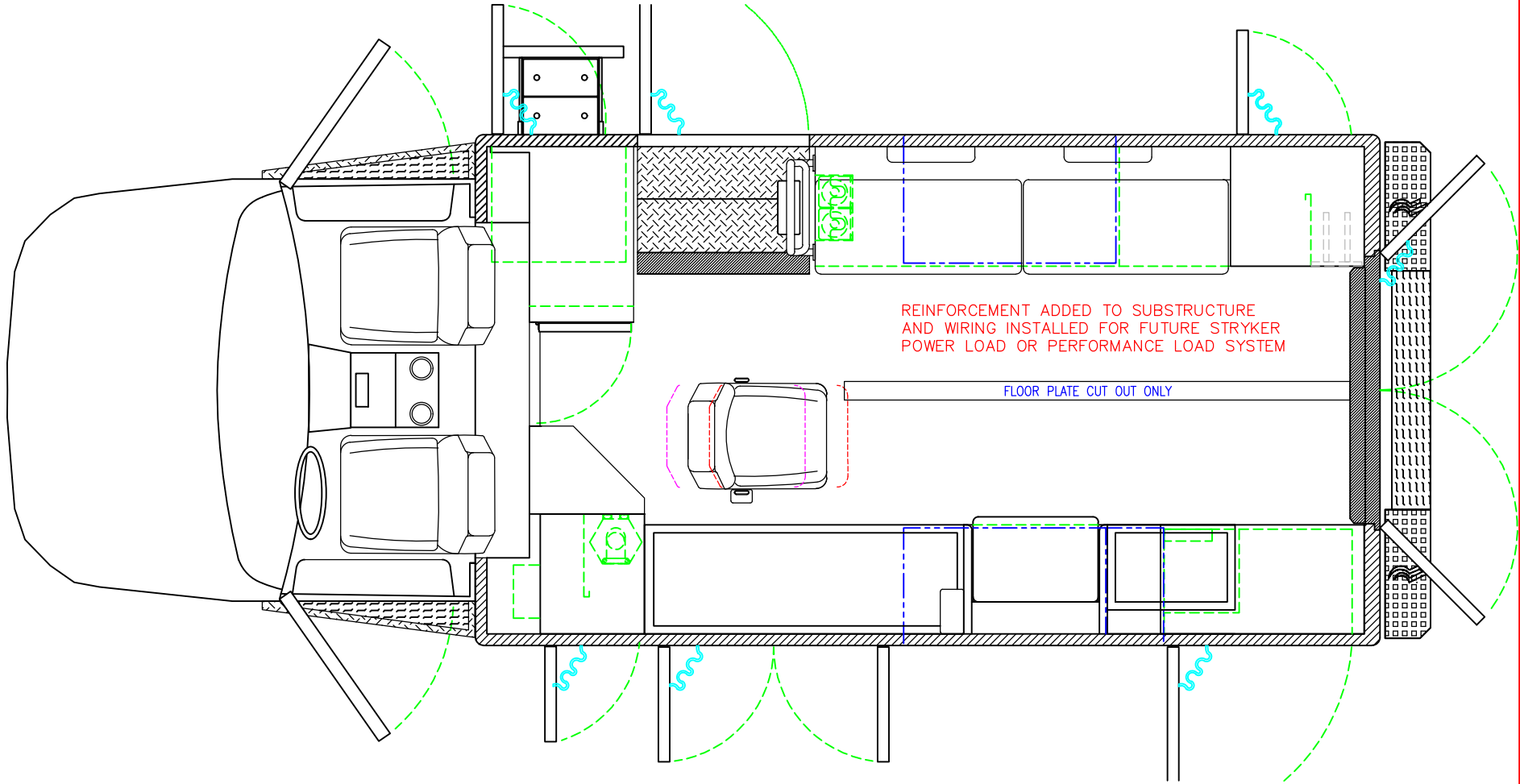

DETAILS ARE CONCEPTUAL ONLY LAYOUT AND ALL DIMENSIONS ARE APPROXIMATE AND SUBJECT TO MODIFICATION BY DESIGN ENGINEERING.

PROPRIETARY AND CONFIDENTIAL
THIS INFORMATION CONTAINED IN THIS DRAWING IS THE SOLE PROPERTY OF ROAD RESCUE ANY REPRODUCTION IN PART OR AS A WHOLE WITHOUT THE WRITTEN PERMISSION OF ROAD RESCUE IS PROHIBITED.

Road Rescue 2737 N. Forsyth Rd.
Winter Park, FL 32792
www.roadrescue.com PHONE 800-932-7077 FAX 800-513-2688
DRAWN BY DATE REVISION 1 REVISION 2 REVISION 3 SCALE
GDG 10/10/2023 11/17/2023

OVERHEAD FLOOR DETAIL

BID NUMBER
 682176



ROAD RESCUE EMERGENCY VEHICLES E-450 ULTRAMEDIC // WALK-THROUGH

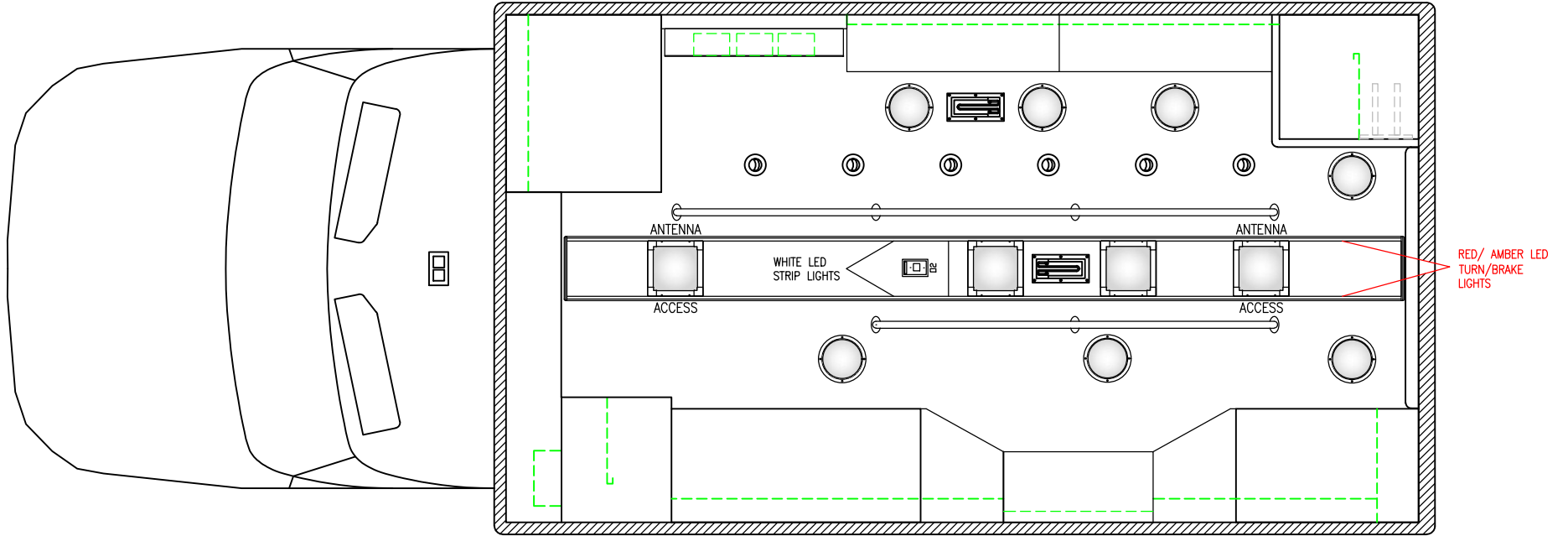

PROPRIETARY AND CONFIDENTIAL
THIS INFORMATION CONTAINED IN THIS DRAWING IS THE SOLE PROPERTY OF ROAD RESCUE ANY REPRODUCTION IN PART OR AS A WHOLE WITHOUT THE WRITTEN PERMISSION OF ROAD RESCUE IS PROHIBITED.

DETAILS ARE CONCEPTUAL ONLY LAYOUT AND ALL DIMENSIONS ARE APPROXIMATE AND SUBJECT TO MODIFICATION BY DESIGN ENGINEERING.

Road Rescue		2737 N. Forsyth Rd. Winter Park, FL 32792		<h2>OVERHEAD CEILING DETAIL</h2>			BID NUMBER	
www.roadrescue.com PHONE 800-932-7077 FAX 800-513-2688								
DRAWN BY GDG	DATE 10/10/2023	REVISION 1	REVISION 2	REVISION 3	SCALE	SHEET 9 OF 10		

NOTE: THIS DRAWING IS SUBJECT TO CHANGE PENDING ROAD RESCUE PRODUCTION ENGINEERING APPROVAL. ©ROAD RESCUE ALL RIGHTS RESERVED.



Road Rescue
Seamless Performance. Enlightened Design.

ROAD RESCUE EMERGENCY VEHICLES E-450 ULTRAMEDIC // WALK-THROUGH



BLACK
POLYURETHANE COATED

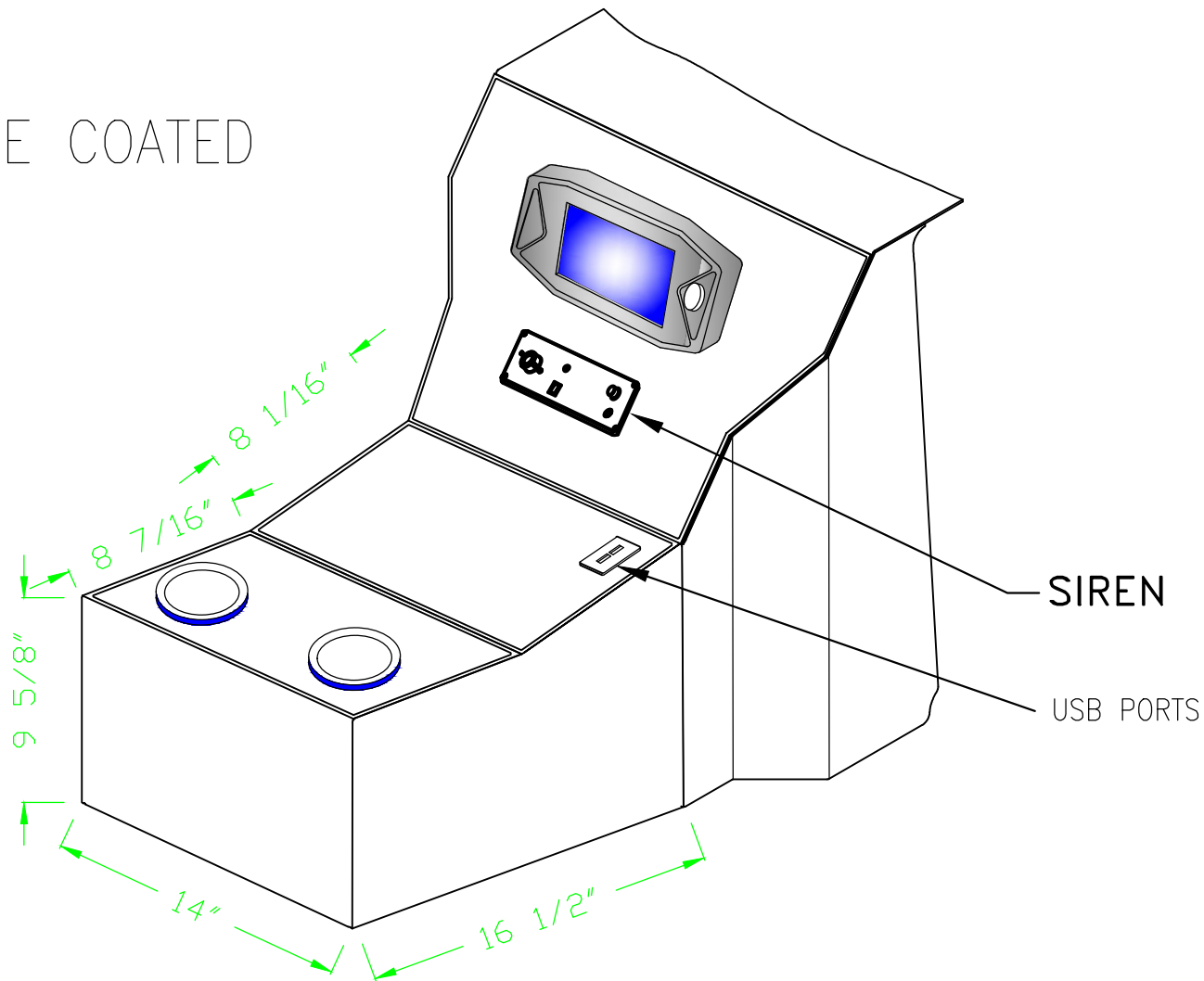

DETAILS ARE CONCEPTUAL ONLY. LAYOUT AND ALL DIMENSIONS ARE APPROXIMATE AND SUBJECT TO MODIFICATION BY DESIGN ENGINEERING.

PROPRIETARY AND CONFIDENTIAL
THIS INFORMATION CONTAINED IN THIS DRAWING IS THE SOLE PROPERTY OF ROAD RESCUE ANY REPRODUCTION IN PART OR AS A WHOLE WITHOUT THE WRITTEN PERMISSION OF ROAD RESCUE IS PROHIBITED.

Road Rescue

2737 N. Forsyth Rd.
Winter Park, FL 32792

www.roadrescue.com PHONE 800-932-7077 FAX 800-513-2688

CONSOLE CONFIGURATION

BID NUMBER

DRAWN BY

DATE

REVISION 1

REVISION 2

REVISION 3

SCALE

SHEET 10 OF 10



682176



NOTE: THIS DRAWING IS SUBJECT TO CHANGE PENDING ROAD RESCUE PRODUCTION ENGINEERING APPROVAL. © ROAD RESCUE ALL RIGHTS RESERVED.