

# BASE FORD AKA METROMEDIC - RediMedic 170" CONFIGURATION 'A'

DEALER SIGNATURE

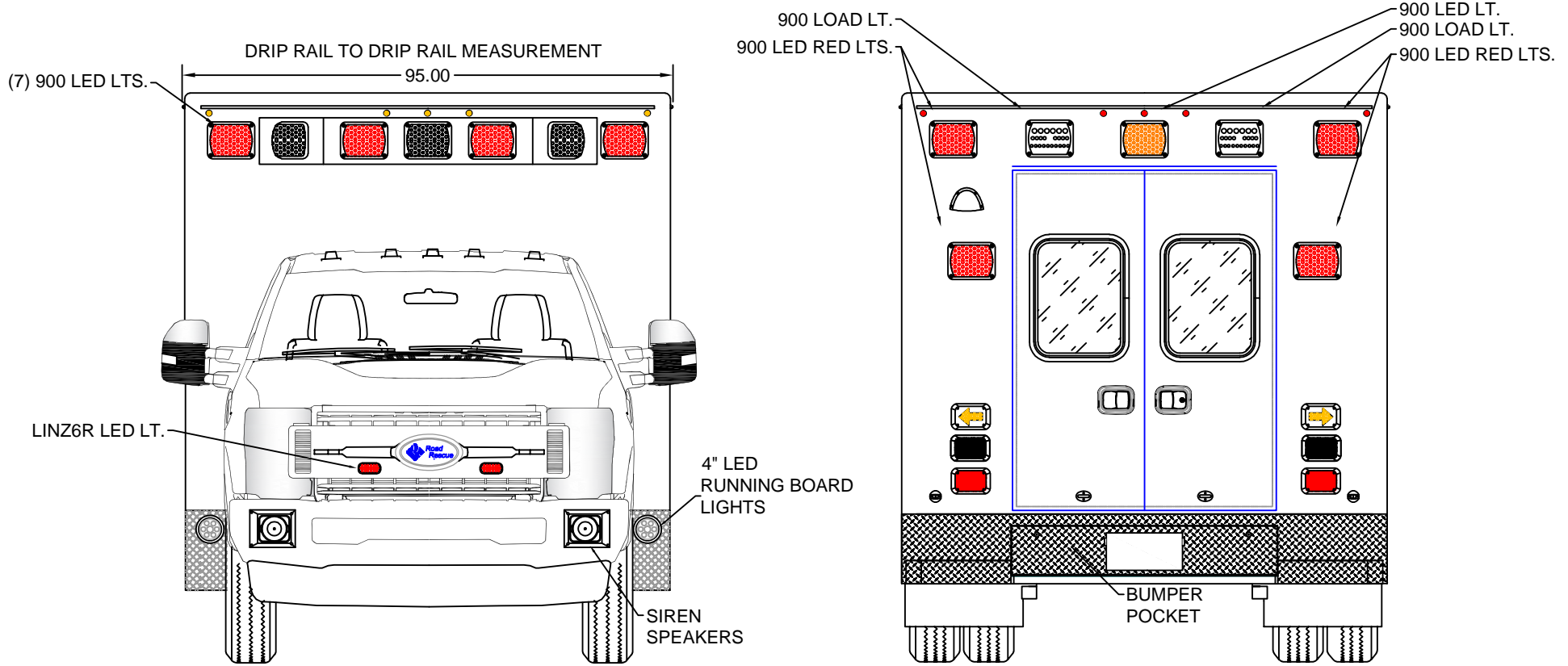
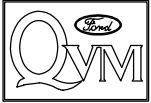

DOOR NO.	INTERIOR DIMENSIONS			NOTES	DOOR NO.	DOOR JAM OPENING		MISC. NOTES	PROPRIETARY AND CONFIDENTIAL THIS INFORMATION CONTAINED IN THIS DRAWING IS THE SOLE PROPERTY OF ROAD RESCUE ANY REPRODUCTION IN PART OR AS A WHOLE WITHOUT THE WRITTEN PERMISSION OF ROAD RESCUE IS PROHIBITED
	HEIGHT	WIDTH	DEPTH			HEIGHT	WIDTH		
DETAILS ARE CONCEPTUAL ONLY. LAYOUT AND ALL DIMENSIONS ARE APPROXIMATE AND SUBJECT TO MODIFICATION BY DESIGN ENGINEERING.									

Road Rescue		2737 N. FORSYTH ROAD WINTER PARK, FL 32792		FRONT REAR EXTERIOR DETAIL			BID NUMBER	
		www.roadrescue.com PHONE 800-932-7077 FAX 800-513-2688					651153	
DRAWN BY	DATE	REVISION 1	REVISION 2	REVISION 3	SCALE	SHEET 1 OF 10		
DLM	08/22/22	11/03/22	12/05/22					

NOTE: THIS DRAWING IS SUBJECT TO CHANGE PENDING ROAD RESCUE PRODUCTION ENGINEERING APPROVAL. © ROAD RESCUE ALL RIGHTS RESERVED.

# BASE FORD AKA METROMEDIC - RediMedic 170" CONFIGURATION 'A'

DEALER SIGNATURE

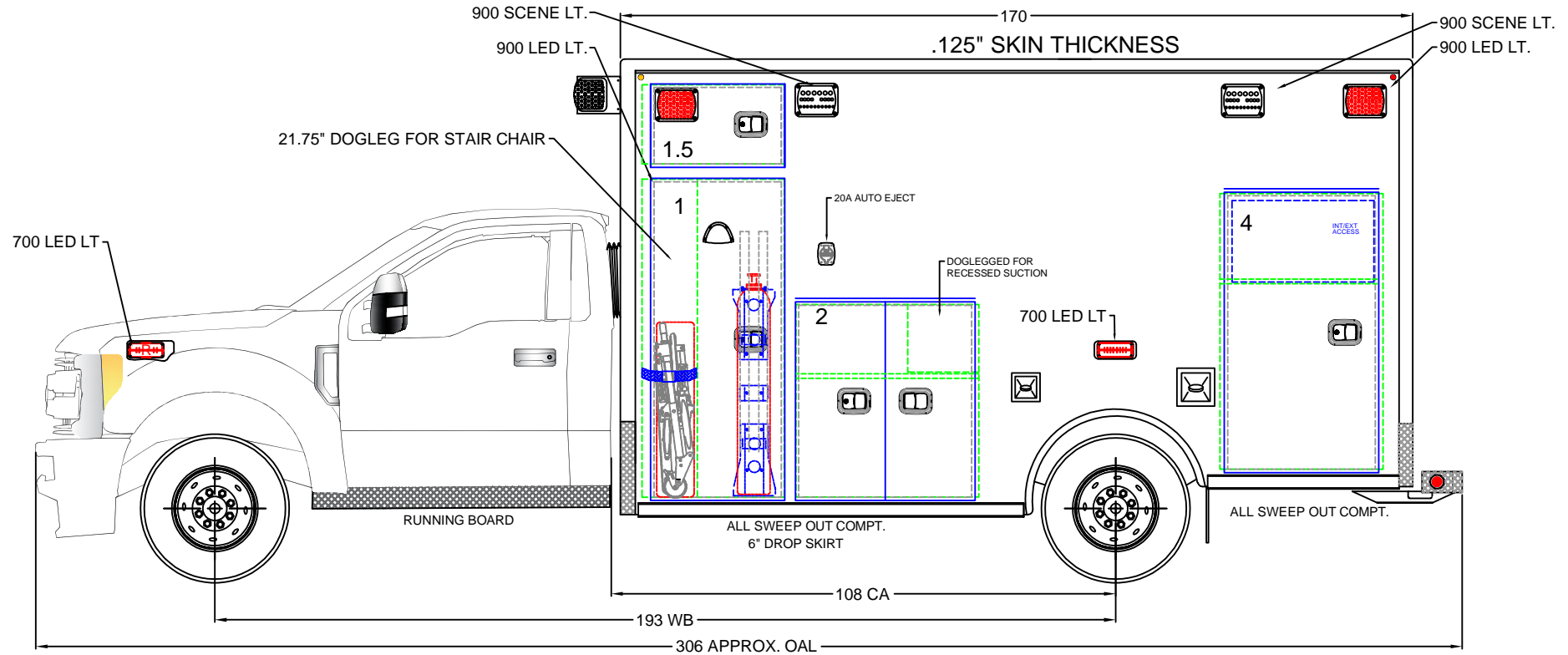
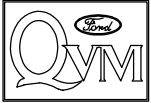

DETAILS ARE CONCEPTUAL ONLY. LAYOUT AND ALL DIMENSIONS ARE APPROXIMATE AND SUBJECT TO MODIFICATION BY DESIGN ENGINEERING.

DOOR INTERIOR DIMENSIONS				DOOR DOOR JAM OPENING				MISC. NOTES	PROPRIETARY AND CONFIDENTIAL THIS INFORMATION CONTAINED IN THIS DRAWING IS THE SOLE PROPERTY OF ROAD RESCUE ANY REPRODUCTION IN PAI OR AS A WHOLE WITHOUT THE WRITTE PERMISSION OF ROAD RESCUE IS PROHITTE
NO.	HEIGHT	WIDTH	DEPTH	NO.	HEIGHT	WIDTH	DEPTH		
4	59.16	34.00	17.00	4	58.50	30.50			
2	42.12	39.25	17.00	2	41.50	37.00			
1.5	20.12	30.50	17.00	1.5	19.50	27.25			
1	65.12	30.50	21.75/17.00	1	64.50	27.25			

<b>Road Rescue</b>		2737 N. FORSYTH ROAD WINTER PARK, FL 32792		<h2>LEFT EXTERIOR DETAIL</h2>		BID NUMBER	
www.roadrescue.com PHONE 800-932-7077 FAX 800-513-2688						651153	
DRAWN BY DLM	DATE 08/22/22	REVISION 1 11/03/22	REVISION 2 12/05/22	REVISION 3	SCALE	SHEET 2 OF 10	

NOTE: THIS DRAWING IS SUBJECT TO CHANGE PENDING ROAD RESCUE PRODUCTION ENGINEERING APPROVAL. © ROAD RESCUE ALL RIGHTS RESERVED.

# BASE FORD AKA METROMEDIC - RediMedic 170" CONFIGURATION 'A'

DEALER SIGNATURE

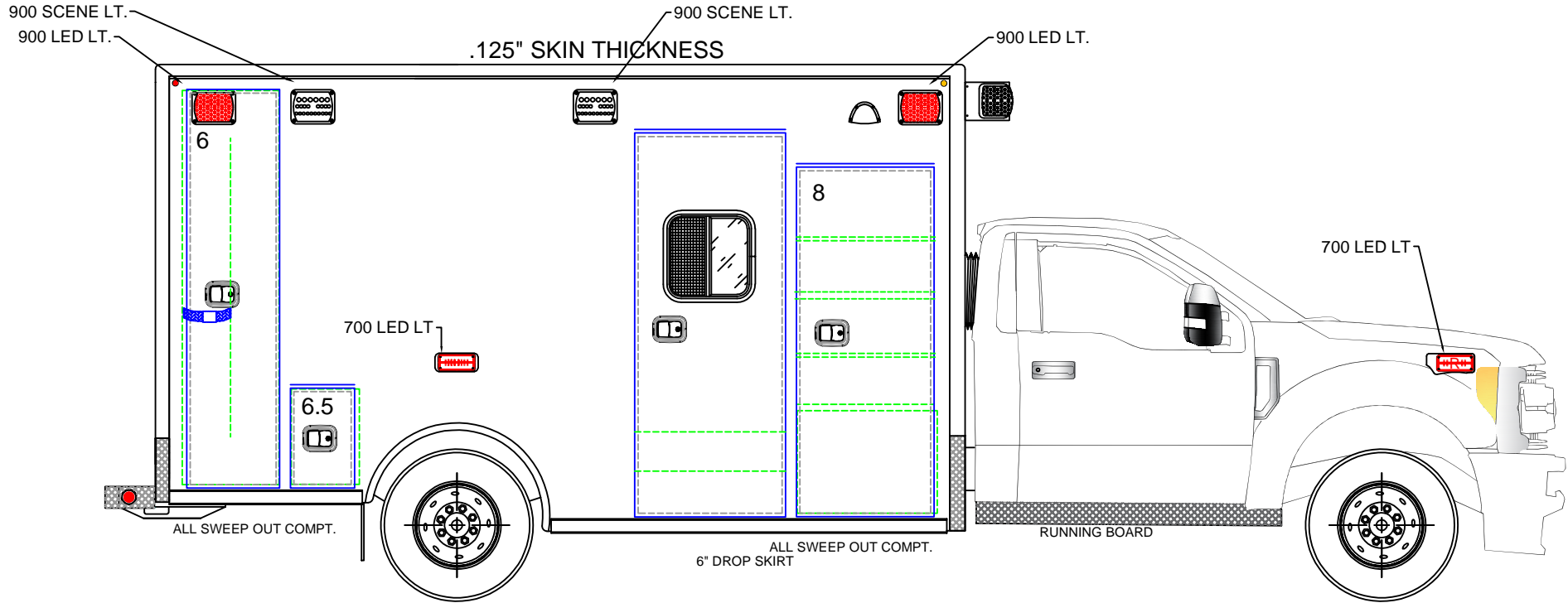

DETAILS ARE CONCEPTUAL ONLY.  
LAYOUT AND ALL DIMENSIONS ARE APPROXIMATE AND  
SUBJECT TO MODIFICATION BY DESIGN ENGINEERING.

DOOR NO.	INTERIOR DIMENSIONS			DOOR NO.	DOOR JAM OPENING			MISC. NOTES	PROPRIETARY AND CONFIDENTIAL THIS INFORMATION CONTAINED IN THIS DRAWING IS THE SOLE PROPERTY OF ROAD RESCUE ANY REPRODUCTION IN PAIR OR AS A WHOLE WITHOUT THE WRITTE PERMISSION OF ROAD RESCUE IS PROHITTE
	HEIGHT	WIDTH	DEPTH		HEIGHT	WIDTH	DEPTH		
8	50.00	31.25	33.50	8	71.50	27.25			
8.5	21.50	30.50	19.00						
6.5	19.87	14.25	17.00	6.5	19.25	12.00			
6	82.46	19.00	18.50	6	81.75	16.87			

<b>Road Rescue</b>		2737 N. FORSYTH ROAD WINTER PARK, FL 32792		<h2>RIGHT EXTERIOR DETAIL</h2>			BID NUMBER	
www.roadrescue.com PHONE 800-932-7077 FAX 800-513-2688							651153	
DRAWN BY DLM	DATE 08/22/22	REVISION 1 11/03/22	REVISION 2 12/05/22	REVISION 3	SCALE	SHEET 3 OF 10		

NOTE: THIS DRAWING IS SUBJECT TO CHANGE PENDING ROAD RESCUE PRODUCTION ENGINEERING APPROVAL. ©ROAD RESCUE ALL RIGHTS RESERVED.



# BASE FORD AKA METROMEDIC - RediMedic 170" CONFIGURATION 'A'

DEALER SIGNATURE

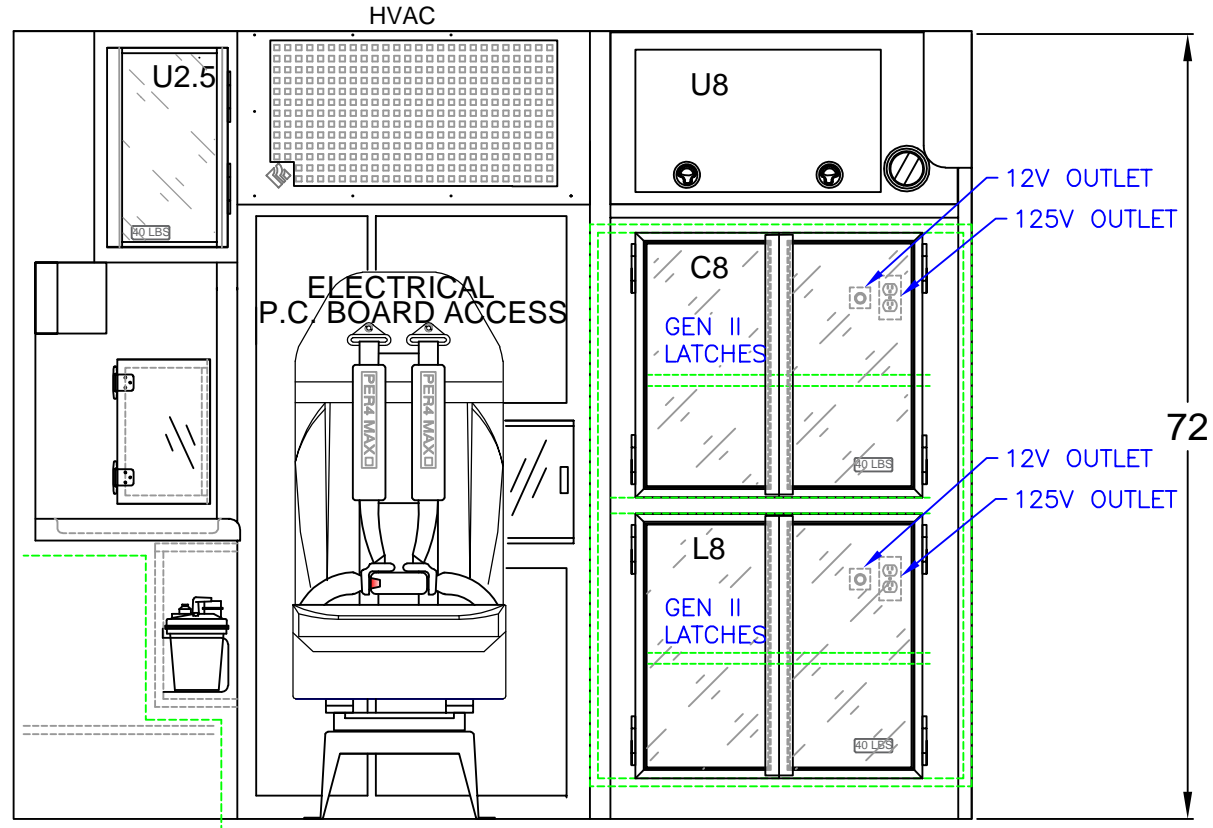

DOOR NO.	CABINET DIMENSIONS			MISC. NOTES
	HEIGHT	WIDTH	DEPTH	
U8	13.25	24.50	32.75	
C8	24.50	33.50	30.50	
L8	24.50	33.50	30.50	

**NOTES:**

DETAILS ARE CONCEPTUAL ONLY. LAYOUT AND ALL DIMENSIONS ARE APPROXIMATE AND SUBJECT TO MODIFICATION BY DESIGN ENGINEERING.

**PROPRIETARY AND CONFIDENTIAL**  
THIS INFORMATION CONTAINED IN THIS DRAWING IS THE SOLE PROPERTY OF ROAD RESCUE ANY REPRODUCTION IN PART OR AS A WHOLE WITHOUT THE WRITTEN PERMISSION OF ROAD RESCUE IS PROHIBITED.

<b>Road Rescue</b>		2737 N. FORSYTH ROAD WINTER PARK, FL 32792		<h2>FRONT INTERIOR DETAIL</h2>			BID NUMBER	
www.roadrescue.com PHONE 800-932-7077 FAX 800-513-2688							651153	
DRAWN BY DLM	DATE 08/22/22	REVISION 1 11/03/22	REVISION 2 12/05/22	REVISION 3	SCALE	SHEET 4 OF 10		

NOTE: THIS DRAWING IS SUBJECT TO CHANGE PENDING ROAD RESCUE PRODUCTION ENGINEERING APPROVAL. ©ROAD RESCUE ALL RIGHTS RESERVED.

# BASE FORD AKA METROMEDIC - RediMedic 170" CONFIGURATION 'A'

DEALER SIGNATURE

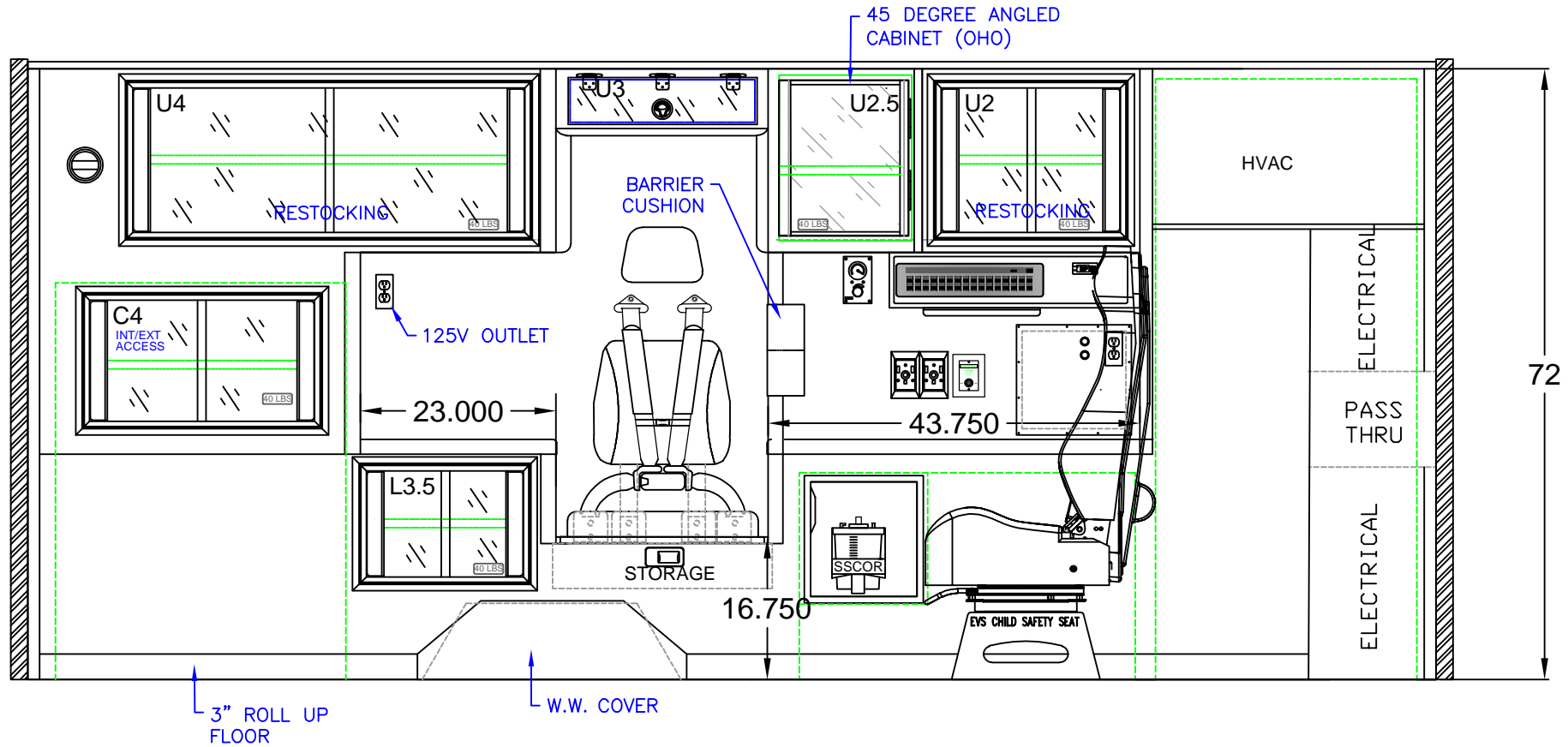
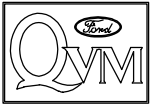

DOOR NO.	CABINET DIMENSIONS			DOOR NO.	CABINET DIMENSIONS		
	HEIGHT	WIDTH	DEPTH		HEIGHT	WIDTH	DEPTH
U2	18.75	29.50	16.00	L3.5	14.25	20.25	18.25
U2.5	18.75	12.75	18.25	C4	18.00	30.00	IS/OS
U3	5.00	22.25	4.00	U4	18.75	48.00	18.25
CPR	4.50	23.50	18.25				

**NOTES:**

DETAILS ARE CONCEPTUAL ONLY. LAYOUT AND ALL DIMENSIONS ARE APPROXIMATE AND SUBJECT TO MODIFICATION BY DESIGN ENGINEERING.

**PROPRIETARY AND CONFIDENTIAL**  
THIS INFORMATION CONTAINED IN THIS DRAWING IS THE SOLE PROPERTY OF ROAD RESCUE ANY REPRODUCTION IN PART OR AS A WHOLE WITHOUT THE WRITTEN PERMISSION OF ROAD RESCUE IS PROHIBITED.

**Road Rescue** 2737 N. FORSYTH ROAD  
WINTER PARK, FL 32792

www.roadrescue.com PHONE 800-932-7077 FAX 800-513-2688

## LEFT INTERIOR DETAIL

BID NUMBER

651153

DRAWN BY: DLM    DATE: 08/22/22    REVISION 1: 11/03/22    REVISION 2: 12/05/22    REVISION 3:    SCALE:    SHEET 5 OF 10

# BASE FORD AKA METROMEDIC - RediMedic 170" CONFIGURATION 'A'

DEALER SIGNATURE

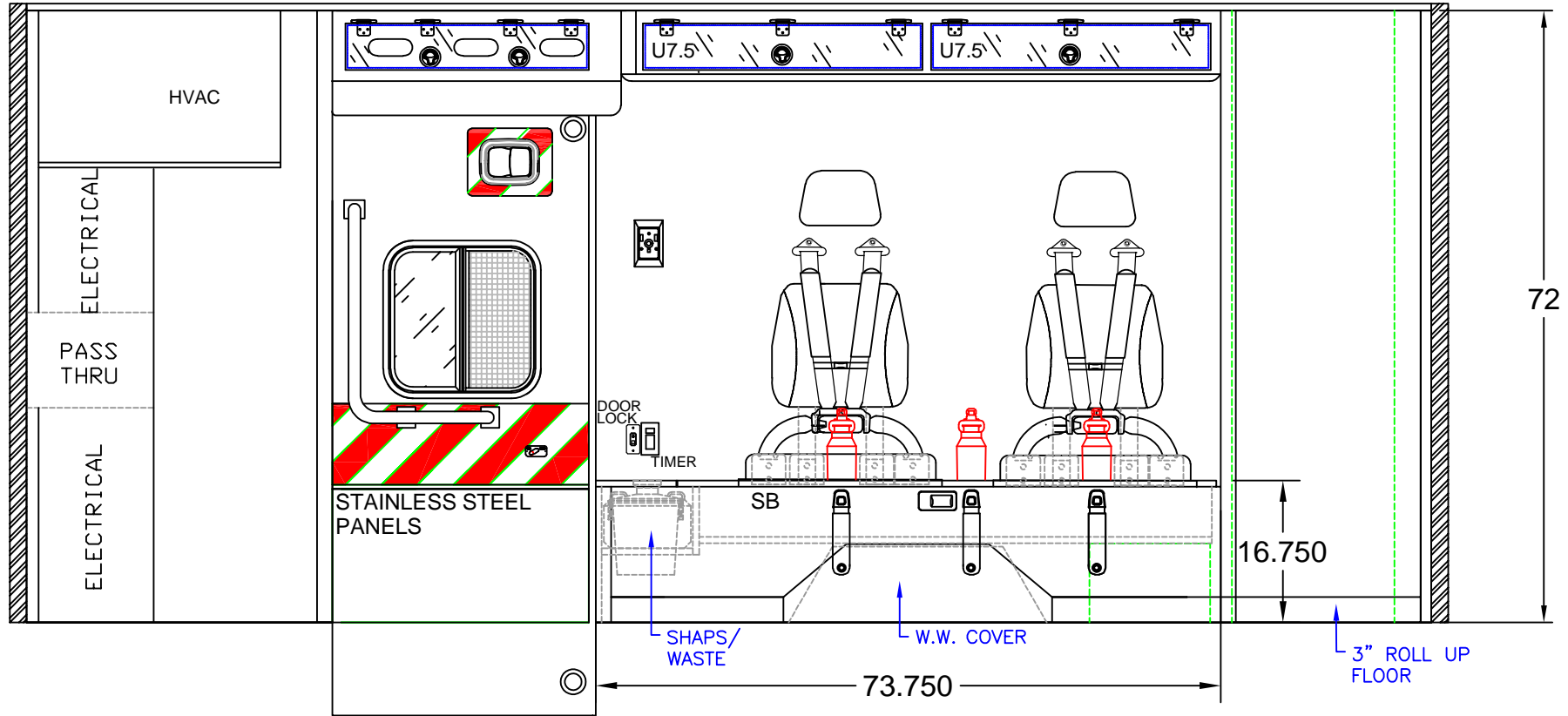
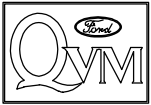

50" AISLE

DOOR NO.	CABINET DIMENSIONS			DOOR NO.	CABINET DIMENSIONS		
	HEIGHT	WIDTH	DEPTH		HEIGHT	WIDTH	DEPTH
SB	5.75	60.75	16.75				
U7	5.00	32.50	7.00				OPTIONAL
U7.5	5.00	32.50	7.00				

NOTES:

DETAILS ARE CONCEPTUAL ONLY. LAYOUT AND ALL DIMENSIONS ARE APPROXIMATE AND SUBJECT TO MODIFICATION BY DESIGN ENGINEERING.

**PROPRIETARY AND CONFIDENTIAL**  
THIS INFORMATION CONTAINED IN THIS DRAWING IS THE SOLE PROPERTY OF ROAD RESCUE ANY REPRODUCTION IN PART OR AS A WHOLE WITHOUT THE WRITTEN PERMISSION OF ROAD RESCUE IS PROHIBITED.

**Road Rescue**

2737 N. FORSYTH ROAD  
WINTER PARK, FL 32792

## RIGHT INTERIOR DETAIL

BID NUMBER

**651153**

www.roadrescue.com PHONE 800-932-7077 FAX 800-513-2688

DRAWN BY: DLM    DATE: 08/22/22    REVISION 1: 11/03/22    REVISION 2: 12/05/22    REVISION 3:    SCALE:    SHEET 6 OF 10



# BASE FORD AKA METROMEDIC - RediMedic 170" CONFIGURATION 'A'

DEALER SIGNATURE

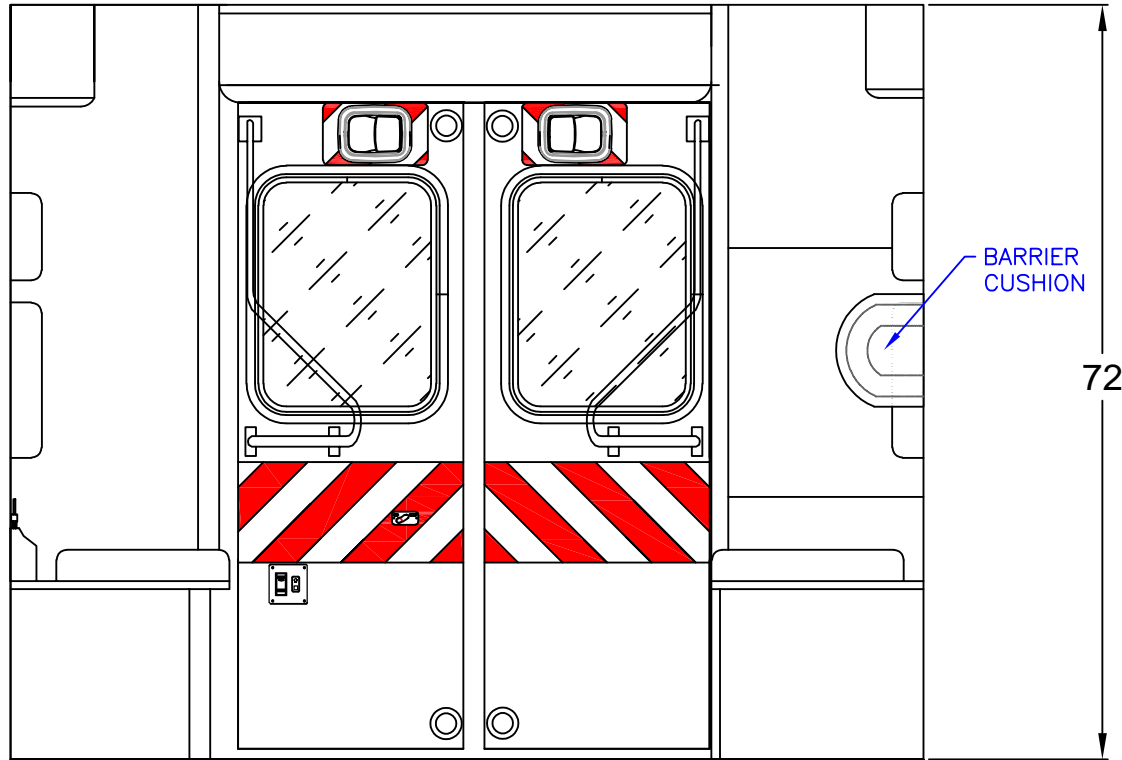

NOTES:

NOTES:

PROPRIETARY AND CONFIDENTIAL  
THIS INFORMATION CONTAINED IN THIS DRAWING IS THE SOLE PROPERTY OF ROAD RESCUE ANY REPRODUCTION IN PART OR AS A WHOLE WITHOUT THE WRITTEN PERMISSION OF ROAD RESCUE IS PROHIBITED

DETAILS ARE CONCEPTUAL ONLY.  
LAYOUT AND ALL DIMENSIONS ARE APPROXIMATE AND SUBJECT TO MODIFICATION BY DESIGN ENGINEERING.

**Road Rescue**

2737 N. FORSYTH ROAD  
WINTER PARK, FL 32792

## REAR INTERIOR DETAIL

BID NUMBER

651153



www.roadrescue.com PHONE 800-932-7077 FAX 800-513-2688

DRAWN BY DLM	DATE 08/22/22	REVISION 1 11/03/22	REVISION 2 12/05/22	REVISION 3	SCALE
-----------------	------------------	------------------------	------------------------	------------	-------

SHEET 7 OF 10

NOTE: THIS DRAWING IS SUBJECT TO CHANGE PENDING ROAD RESCUE PRODUCTION ENGINEERING APPROVAL. ©ROAD RESCUE ALL RIGHTS RESERVED.



# BASE FORD AKA METROMEDIC - RediMedic 170" CONFIGURATION 'A'

DEALER SIGNATURE

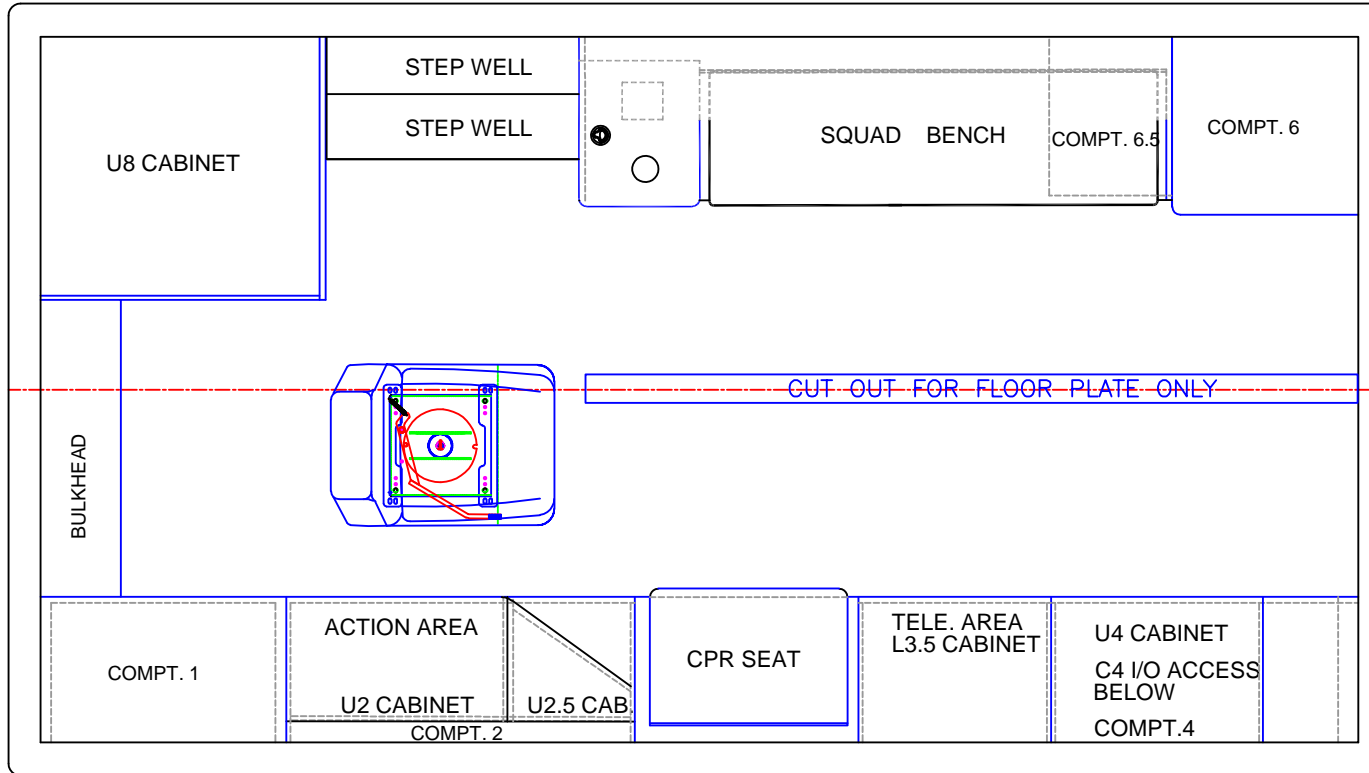

NOTES:

NOTES:  
  
DETAILS ARE CONCEPTUAL ONLY.  
LAYOUT AND ALL DIMENSIONS ARE APPROXIMATE AND  
SUBJECT TO MODIFICATION BY DESIGN ENGINEERING.

PROPRIETARY AND  
CONFIDENTIAL  
THIS INFORMATION  
CONTAINED IN THIS  
DRAWING IS THE SOLE  
PROPERTY OF ROAD  
RESCUE ANY  
REPRODUCTION IN PAI  
OR AS A WHOLE  
WITHOUT THE WRITTE  
PERMISSION OF ROAD  
RESCUE IS PROHIBITE!

**Road Rescue** 2737 N. FORSYTH ROAD  
WINTER PARK, FL 32792  
www.roadrescue.com PHONE 800-932-7077 FAX 800-513-2688

## OVERHEAD FLOOR DETAIL

BID NUMBER

651153

DRAWN BY DLM	DATE 08/22/22	REVISION 1 11/03/22	REVISION 2 12/05/22	REVISION 3	SCALE
-----------------	------------------	------------------------	------------------------	------------	-------

SHEET 8 OF 10





# BASE FORD AKA METROMEDIC - RediMedic 170" CONFIGURATION 'A'

DEALER SIGNATURE

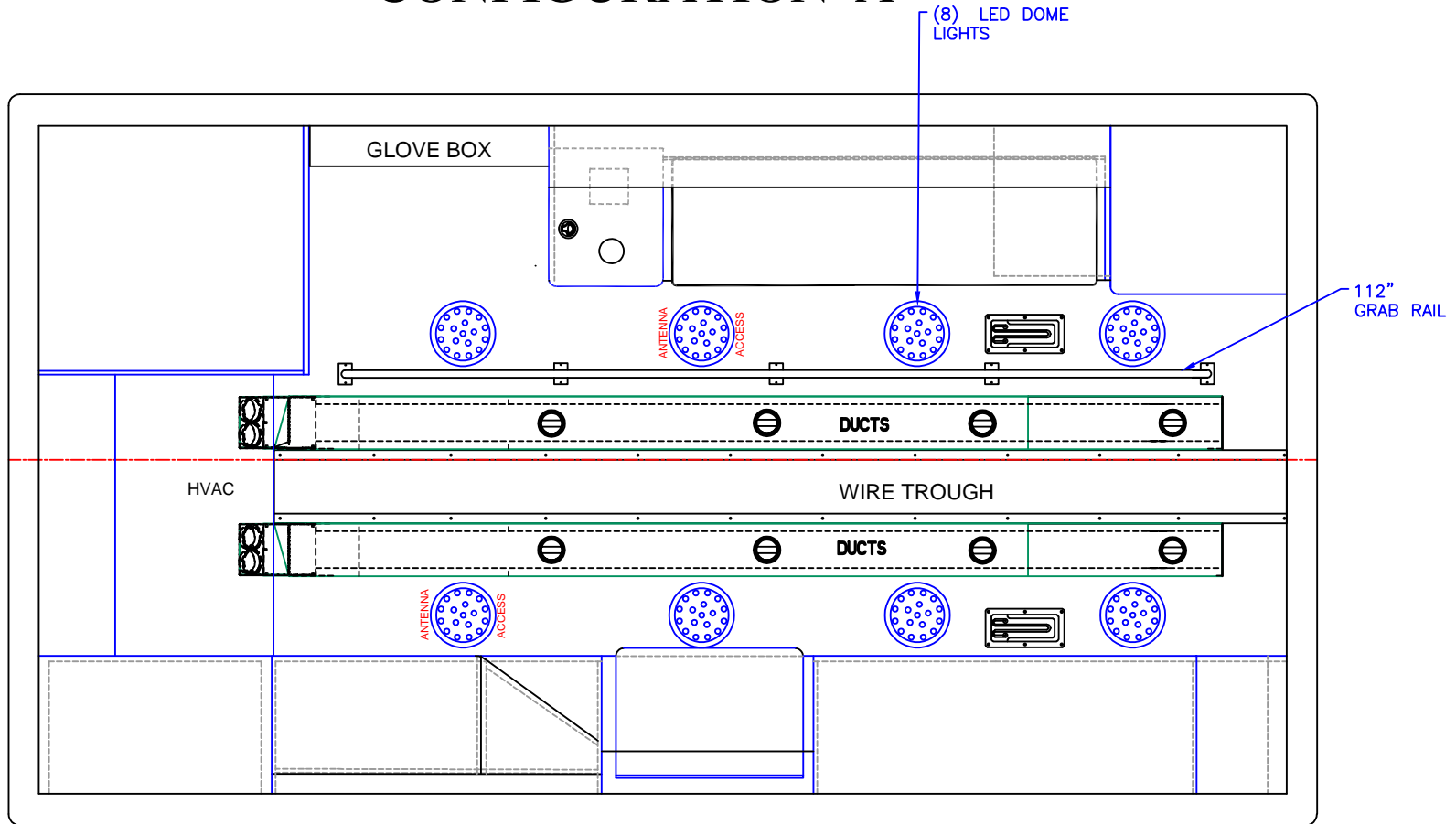
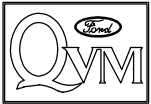

NOTES:

NOTES:

PROPRIETARY AND CONFIDENTIAL  
THIS INFORMATION CONTAINED IN THIS DRAWING IS THE SOLE PROPERTY OF ROAD RESCUE ANY REPRODUCTION IN PART OR AS A WHOLE WITHOUT THE WRITTEN PERMISSION OF ROAD RESCUE IS PROHIBITED

DETAILS ARE CONCEPTUAL ONLY.  
LAYOUT AND ALL DIMENSIONS ARE APPROXIMATE AND SUBJECT TO MODIFICATION BY DESIGN ENGINEERING.

**Road Rescue**

2737 N. FORSYTH ROAD  
WINTER PARK, FL 32792

## OVERHEAD CEILING DETAIL

BID NUMBER



www.roadrescue.com PHONE 800-932-7077 FAX 800-513-2688

DRAWN BY DLM	DATE 08/22/22	REVISION 1 11/03/22	REVISION 2 12/05/22	REVISION 3	SCALE
-----------------	------------------	------------------------	------------------------	------------	-------

REVISION 1 11/03/22	REVISION 2 12/05/22	REVISION 3
------------------------	------------------------	------------

SCALE

SHEET 9 OF 10



651153

# BASE FORD AKA METROMEDIC - RediMedic 170" CONFIGURATION 'A'

DEALER SIGNATURE

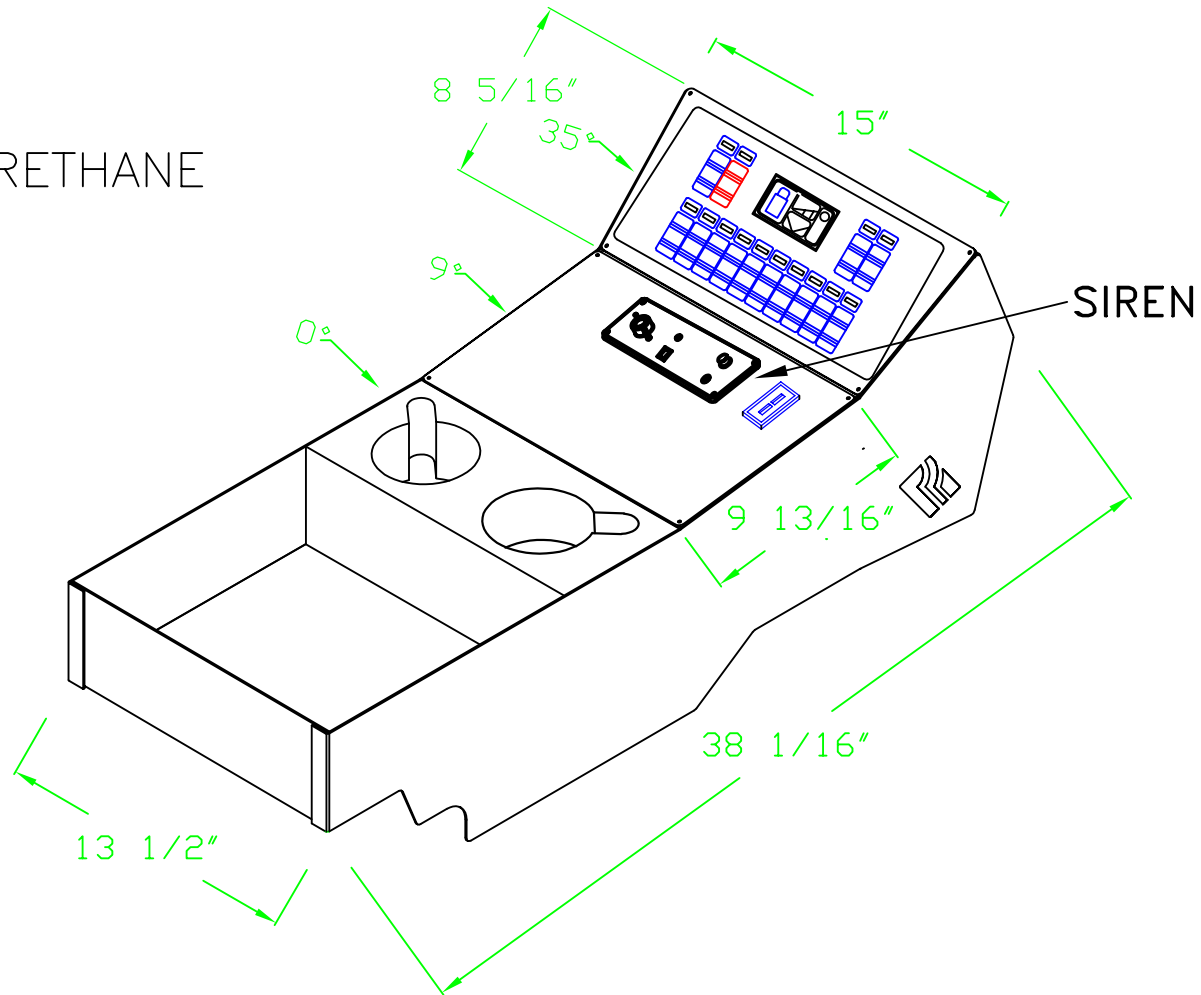

BLACK POLYURETHANE  
COATED



DETAILS ARE CONCEPTUAL ONLY. LAYOUT AND ALL DIMENSIONS ARE APPROXIMATE AND SUBJECT TO MODIFICATION BY DESIGN ENGINEERING.

PROPRIETARY AND CONFIDENTIAL  
THIS INFORMATION CONTAINED IN THIS DRAWING IS THE SOLE PROPERTY OF ROAD RESCUE ANY REPRODUCTION IN PART OR AS A WHOLE WITHOUT THE WRITTEN PERMISSION OF ROAD RESCUE IS PROHIBITED

**Road Rescue**

2737 N. FORSYTH ROAD  
WINTER PARK, FL 32792

## CAB CONSOLE

BID NUMBER

651153

www.roadrescue.com PHONE 800-932-7077 FAX 800-513-2688

DRAWN BY DLM	DATE 08/22/22	REVISION 1 11/03/22	REVISION 2 12/05/22	REVISION 3	SCALE	SHEET 10 OF 10
-----------------	------------------	------------------------	------------------------	------------	-------	----------------



NOTE: THIS DRAWING IS SUBJECT TO CHANGE PENDING ROAD RESCUE PRODUCTION ENGINEERING APPROVAL. ©ROAD RESCUE ALL RIGHTS RESERVED.